

# **Wireless Communications And Networks Course file**

# **Contents**

## **Courses file Contents:**

- 1. Cover Page**
- 2. Syllabus copy**
- 3. Vision of the Department**
- 4. Mission of the Department**
- 5. PEOs and POs**
- 6. Course objectives and outcomes**
- 7. Brief note on the importance of the course and how it fits into the curriculum**
- 8. Prerequisites, if any**
- 9. Instructional Learning Outcomes**
- 10. Prerequisites, if any**
- 11. Course mapping with POs**
- 12. Class Time Table**
- 13. Individual Time Table**
- 14. Lecture schedule with methodology being used**
- 15. Detailed notes**
- 16. University Question papers of previous years**
- 17. Question Bank**
- 18. Assignment topics**
- 19. Unit wise Quiz questions and long answer questions**
- 20. Tutorial problems**
- 21. Known gaps, if any and inclusion of same in the lecture schedule**
- 22. Discussion topics, if any**
- 23. References, Journals, websites and E-links**
- 24. Quality measurement sheets**
  - a) Course end survey**
  - b) Teaching evaluation**
- 25. Student List**
- 26. Group-Wise students list for discussion topics.**

# 1. Cover page:

## GEETHANJALI COLLEGE OF ENGINEERING AND TECHNOLOGY

### DEPARTMENT OF Electronics and Communication Engineering

(Name of the Subject / Lab Course) : wireless Communications and Networks

(JNTU CODE 58023)

Programme : UG

Branch: ECE

Version No : 01 , dated: 29/11/15

Year: IV Year ECE

Document Number : GCET/ECE/58023 / 01

Semester: II

No. of pages :

Classification status (Unrestricted / Restricted )

Distribution List : Dept Library / Dept office /concerned staff

Prepared by :

updated by :

1) Name : Y.SIVARAMAKRISHNA

1) Name : Mrs.Ramadevi

2) Sign :

2) Sign :

3) Design : Asst. Professor

3) Design : Asst. Professor

4) Date : 29/11/2015

4) Date : 29/11/2015

Verified by :

\* For Q.C.only

1) Name :

1) Name :

2) Sign :

2) Sign :

3) Design :

3) Design :

4) Date :

4) Date :

## 2. Syllabus:

### JAWAHARLAL NEHRU TECHNOLOGICAL UNIVERSITY HYDERABAD

IV Year B.Tech. ECE.II-Sem

T	P	C
4+1*	0	4

### WIRELESS COMMUNICATIONS AND NETWORKS (ELECTIVE – IV)

#### UNIT I

**Introduction to wireless communication systems:** Evaluation of mobile radio communications, examples of wireless communication systems, paging systems, cordless telephone systems, compression of various wireless systems.

#### UNIT II

**Mobile wireless communication systems:** second generation cellular networks, third generation wireless networks, wireless in local loop, wireless local area networks, Bluetooth and personal area networks.

#### UNIT III

**Cellular system design fundamentals:** spectrum allocation, basic cellular system, frequency reuse, channel assignment strategies, handoff strategies, interference and system capacity, trucking and grade off service, improving coverage and capacity, cell splitting.

#### UNIT IV

**Multiple access technique for wireless communications:** introduction to multiple accesses, FDMA, TDMA, spread spectrum multiple access, SDMA, packet radio, capacity of cellular systems.

#### UNIT V

**Wireless Networking:** Difference between wireless and fixed telephone networks, development of wireless networks, fixed network transmission hierarchy, traffic routing in wireless networks, wireless data services, common channel signaling.

#### UNIT VI

**Wireless WAN:** mechanism to support at mobile environment, communication in the infrastructure, IS-95 CDMA forward channel, IS-95 CDMA reverse channel, packet and frame formats in IS-95, IMT-2000, forward channel in W-CDMA and CDMA 2000, reverse channels in W-CDMA and CDMA-2000 GPRS and higher data rates, short messaging service in GPRS mobile application protocols.

#### UNIT VII

**Wireless LAN:** Historical overviews of the LAN industry, evolution of the WAN industry, wireless home networking IEEE 802.11 the PHY layer, MAC layer wireless ATM, Hyperlink, HyperLAN-2

## **UNIT VIII**

**Orthogonal frequency division multiplexing:** basic principles of orthogonality single versus multi channel systems, OFDM block diagram, and its exokanatiion, OFDM signal mathematical representation.

### **TEXT BOOKS:**

1. Wireless Communications, Principles, Practice – Theodore, S. Rappaport, PHI, 2nd Edn., 2002.
2. Wireless Communication and Networking – William Stallings, PHI, 2003.

### **REFERENCES :**

1. Wireless Digital Communications – Kamilo Feher, PHI, 1999.
2. Principles of Wireless Networks – Kaveh Pah Laven and P. Krishna Murthy, Pearson Education, 2002.
3. Wireless Communications – Andreaws F. Molisch, Wiley India, 2006.
4. Introduction to Wireless and Mobile Systems – Dharma Prakash Agarwal, Qing-An Zeng, Thomson 2<sup>nd</sup> Edition, 2006.

## **3. Vision of the Department:**

To impart quality technical education in Electronics and Communication Engineering emphasizing analysis, design/synthesis and evaluation of hardware/embedded software using various Electronic Design Automation (EDA) tools with accent on creativity, innovation and research thereby producing competent engineers who can meet global challenges with societal commit

## **4. Mission of the Department:**

- i. To impart quality education in fundamentals of basic sciences, mathematics, electronics and communication engineering through innovative teaching-learning processes.
- ii. To facilitate Graduates define, design, and solve engineering problems in the field of Electronics and Communication Engineering using various Electronic Design Automation (EDA) tools.
- iii. To encourage research culture among faculty and students thereby facilitating them to be creative and innovative through constant interaction with R & D organizations and Industry.
- iv. To inculcate teamwork, imbibe leadership qualities, professional ethics and social responsibilities in students and faculty.

## **5. Program Educational Objectives of B. Tech (ECE) Program:**

- I. To prepare students with excellent comprehension of basic sciences, mathematics and engineering subjects facilitating them to gain employment or pursue postgraduate studies with an appreciation for lifelong learning.
- II. To train students with problem solving capabilities such as analysis and design with adequate practical skills wherein they demonstrate creativity and innovation that would enable them to develop state of the art equipment and technologies of multidisciplinary nature for societal development.
- III. To inculcate positive attitude, professional ethics, effective communication and interpersonal skills which would facilitate them to succeed in the chosen profession exhibiting creativity and innovation through research and development both as team member and as well as leader.

## **Program Outcomes of B.Tech ECE Program:**

1. An ability to apply knowledge of Mathematics, Science, and Engineering to solve complex engineering problems of Electronics and Communication Engineering systems.
2. An ability to model, simulate and design Electronics and Communication Engineering systems, conduct experiments, as well as analyze and interpret data and prepare a report with conclusions.
3. An ability to design an Electronics and Communication Engineering system, component, or process to meet desired needs within the realistic constraints such as economic, environmental, social, political, ethical, health and safety, manufacturability and sustainability.
4. An ability to function on multidisciplinary teams involving interpersonal skills.
5. An ability to identify, formulate and solve engineering problems of multidisciplinary nature.
6. An understanding of professional and ethical responsibilities involved in the practice of Electronics and Communication Engineering profession.
7. An ability to communicate effectively with a range of audience on complex engineering problems of multidisciplinary nature both in oral and written form.
8. The broad education necessary to understand the impact of engineering solutions in a global, economic, environmental and societal context.
9. Recognition of the need for, and an ability to engage in life-long learning and acquire the capability for the same.

10. A knowledge of contemporary issues involved in the practice of Electronics and Communication Engineering profession
11. An ability to use the techniques, skills and modern engineering tools necessary for engineering practice.
12. An ability to use modern Electronic Design Automation (EDA) tools, software and electronic equipment to analyze, synthesize and evaluate Electronics and Communication Engineering systems for multidisciplinary tasks.
13. Apply engineering and project management principles to one's own work and also to manage projects of multidisciplinary nature.

### Mapping of Course with Programme Educational Objectives:

S.No	Course component	code	course	Semester	PEO 1	PEO 2	PEO 3
1	WCN		WCN	II	√	√	

### 6. Course objectives:

- To understand the examples of wireless communication systems, paging systems, cordless telephone systems.
- To study the different generations of mobile networks, WAN and PAN.
- To understand the concepts of basic cellular system, frequency reuse, channel assignment strategies, handoff strategies, interference.
- To understand the FDMA, TDMA, spread spectrum multiple access.
- To study the Wireless Networking: Difference between wireless and fixed telephone networks, development of wireless networks.
- To study the concepts mobile environment, communication in the infrastructure , iIS-95 CDMA forward channel, IS-95 CDMA risers channel, packet and frame formats in IS-95,IMT -20000.
- To understand the evolution of the WAN industry, wireless home networking IEEE 802.11 the PHY layer.
- To understand the concepts of orthogonal frequency division multiplexing.

## **Outcomes of the subject:**

### **Students are**

- Able to understand the examples of wireless communication systems, paging systems, cordless telephone systems.
- To understand the second generation cellular networks, third generation wireless networks, wireless in local loop, wireless local area networks, Bluetooth and personal area networks.
- Able to understand the concepts of spectrum allocation, basic cellular system, frequency reuse, channel assignment strategies, handoff strategies, interference, improving coverage and capacity, cell splitting.
- To understand various multiple access techniques: FDMA, TDMA, spread spectrum multiple access, SDMA.
- To understand the difference between wireless and fixed telephone networks, development of wireless networks.
- Able to understand the communication in the infrastructure, IS-95 CDMA forward channel, IS-95 CDMA reverse channel, packet and frame formats in IS-95, IMT-2000, forward channel in W-CDMA.
- Able to understand the historical overviews of the land industry, evolution of the WAN industry, wireless home networking IEEE 802.11 the physical layer, MAC layer wireless ATM.
- To understand the concepts of orthogonal frequency division multiplexing: basic principles of orthogonality single versus multi channel systems, OFDM block diagram.

## **7. Brief note on the importance of the course and how it fits into the curriculum:**

This course uses assigned readings, lectures, and homework to enable the students to:

- a. Ability to understand the fundamentals of antennas and wave propagation.
- b. Understand the basics of cordless telephone systems.
- c. Able to understand the concepts of wireless LAN and Bluetooth technologies.
- d. Able to understand the concepts of frequency reuse, hand-off strategies and cell-splitting.
- e. Ability to understand the different multiple access techniques, differences between wireless and fixed telephone systems, ATM and orthogonal frequency division multiplexing.



## 8. Prerequisites, if any:

Students should be well-versed with the fundamentals of antennas and wave-propagation, various analog and digital modulation techniques and brief knowledge on cellular and mobile communications.

## 9. Instructional Learning Outcomes:

### Outcomes:

On successful completion of this subject, students will be able to:

1. Understand examples of wireless communication systems, paging systems, cordless telephone systems.
2. Understand the differences second generation cellular networks, third generation wireless networks, wireless in local loop, wireless local area networks, Bluetooth and personal area networks.
3. Understand the concepts of spectrum allocation, basic cellular system, frequency reuse, channel assignment strategies, handoff strategies and interference.
4. Difference between wireless and fixed telephone networks, development of wireless networks, fixed network transmission hierarchy, traffic routing in wireless networks, wireless data services.

## 10. Course mapping with PEOs and Pos:

### Course Mapping with PEO's and PO's:

a) an ability to apply the knowledge of Mathematics, science and engineering in Electronics and communications	
b) an ability to Design & Conduct Experiments, as well as analyze & Interpret Data	✓
c) an ability to design a system, component, or process to meet desired needs with in realistic constraints such as economic, environmental, social, political, ethical, health and safety, manufacturability, and sustainability	✓
d) an ability to function on multidisciplinary teams	✓

e) an ability to Identify, Formulate & Solve problems in the area of Electronics and Communications Engineering	✓
f) an understanding of professional and ethical responsibility	
g) an ability to communicate effectively	
h) the broad education necessary to understand the impact of engineering solutions in a global, economic, environmental, and societal context	✓
i) a recognition of the need for, and an ability to engage in life-long learning	✓
j) a knowledge of contemporary issues	✓
k) an ability to use the techniques, skills, and modern engineering tools necessary for engineering practice	✓

1. <b><u>Domain knowledge:</u></b> Graduates will be able to synthesize mathematics, science, engineering fundamentals, laboratory and work-based experiences to formulate and solve engineering problems in Electronics and Communication engineering domains and shall have proficiency in Computer-based engineering and the use of computational tools.	✓
2. <b><u>Professional Employment:</u></b> Graduates will succeed in entry-level engineering positions within the core Electronics and Communication Engineering, computational or manufacturing firms in regional, national, or international industries and with government agencies.	✓
3. <b><u>Higher Degrees:</u></b> Graduates will succeed in the pursuit of advanced degrees in Engineering or other fields where a solid foundation in mathematics, science, and engineering fundamentals is required.	✓
4. <b><u>Engineering citizenship:</u></b> Graduates will be prepared to communicate and work effectively on team based engineering projects and will practice the ethics of their profession consistent with a sense of social responsibility.	
5. <b><u>Lifelong Learning:</u></b> Graduates will recognize the importance of, and have the skills for, continued independent learning to become experts in their chosen fields and to broaden their professional knowledge.	✓
6. <b><u>Research and Development:</u></b> To undertake Research and Development works in the areas of Electronics and Communication fields.	✓

### Mapping of Course with Programme Educational Objectives:

S.No	Course component	code	course	Semester	PEO 1	PEO 2	PEO 3
1	WCN		WCN	II	✓	✓	

## 10. Course mapping with PEOs and POs:

\*When the course outcome weightage is < 40%, it will be given as moderately correlated (1).

\*When the course outcome weightage is >40%, it will be given as strongly correlated (2).

POs	1	2	3	4	5	6	7	8	9	10	11	12
<b>WCN</b>												
Would be able to understand the concepts of Multiple Access Techniques for Wireless Communication			<b>2</b>	<b>1</b>	2		<b>2</b>	2			2	
Able to understand the different generations of cellular networks, wireless local area networks, Bluetooth	<b>2</b>			<b>2</b>	2						1	
Would be able to understand the basic cellular system, frequency reuse, channel assignment strategies, handoff strategies, interference	<b>2</b>					2					1	
Able to understand the concepts of the Multiple access technique for wireless communications	<b>2</b>				2		<b>1</b>				2	
Would be able to understand the concepts of	<b>2</b>				2		<b>1</b>				2	

Difference between wireless and fixed telephone networks, development of wireless networks, fixed network transmission hierarchy												
Able to understand the Wireless WAN, CDMA 2000	1			2		1				2		
Able to understand the Wireless LAN, IEEE 802.11 the Physical layer	1			2		1	2			2		
Would be able to understand the Orthogonal frequency division multiplexing	2			2		1				2		

**11. Class time table:**

**12. Individual Time Table:**

**13. Lecture schedule with methodology being used:**

**Programme : B.Tech**

**Faculty Name: Mr. Y.SIVARAMAKRISHNA**

**Year & Sem: IV -II Sem.**

**Asst. Professor**

**Branch: ECE**

**Dept: ECE**

**Subject name: WCN**

S. No		Topics to be covered	No. of lecture hrs required	Black board/ OHP/ Projector
<b>Introduction to wireless communication systems:</b>				
1.	UNIT I	<b>Introduction to wireless communication systems</b>	1	Black board and Projector
2.		evaluation of mobile radio communications	1	Black board and Projector
3.		examples of wireless communication systems	1	Black board and Projector
4.		paging systems, cordless telephone systems	1	Black board and Projector
5.		compression of various wireless systems	1	Black board and Projector
6.		<b>Tutorial class</b>	1	
7.		<b>polling-Token Passing</b>	1	Black board and Projector
			7	
<b>Mobile wireless communication systems,</b>				
1.	UNIT II	<b>Mobile wireless communication systems:</b>	1	Black board and Projector
2.		second generation cellular networks	1	Black board and Projector
3.		third generation wireless networks,	1	Black board and Projector
4.		wireless in local loop, wireless local area networks	1	Black board and Projector
5.		Bluetooth and personal area networks	1	Black board and Projector
6.		<b>Tutorial class</b>	1	
7.		<b>Solving university Papers</b>	1	Black board
8.		<b>Assignment</b>	1	Black board
			<b>8</b>	
<b>Cellular system design fundamentals</b>				
1.	U	<b>Cellular system design</b>	1	Black board and Projector

		<b>fundamentals:</b>		
2.		spectrum allocation, basic cellular system, frequency reuse	1	Black board and Projector
3.		channel assignment strategies, handoff strategies	1	Black board and Projector
4.		interference and system capacity, trucking and grade off service	1	Black board and Projector
5.		Improving coverage and capacity, cell splitting.	1	Black board and Projector
6.		<b>Tutorial class</b>	1	
		<b>Overview</b>	1	Black board
			<b>7</b>	
<b>Multiple access technique for warless communications:</b>				
1.		<b>Multiple access technique for warless communications</b>	1	Black board and Projector
2.		introduction to multiple accesses	1	Black board and Projector
3.		FDMA, TDMA	1	Black board and Projector
4.		spread spectrum multiple access, SDMA	1	Black board and Projector
5.		Packet radio, capacity of cellular systems.	1	Black board and Projector
6.		<b>Tutorial class</b>	1	Black board and Projector
7.		<b>Assignment</b>	1	Black board and Projector
8.		<b>Solving university Papers</b>	1	Black board and Projector
9.			<b>8</b>	
<b>Wireless Networking:</b>				
1.		Wireless Networking	1	Black board and Projector
2.		Difference between wireless and fixed telephone networks	1	Black board and Projector
3.		development of wireless networks, fixed network transmission hierarchy	1	Black board and Projector

4.		traffic routing in wireless networks, wireless data services	1	Black board and Projector
5.		common channel signaling	1	Black board and Projector
		<b>Tutorial class</b>	1	Black board and Projector
		<b>Other IEEE 802.11 standards</b>	1	Black board and Projector
			<b>7</b>	Black board and Projector
<b>Wireless WAN</b>				
1.	UNIT VI	<b>Wireless WAN:</b> mechanism to support at mobile environment	1	Black board and Projector
2.		communication in the infrastructure, IS-95 CDMA forward channel	1	Black board and Projector
3.		IS-95 CDMA reverse channel, packet and frame formats in IS-95, IMT-2000	1	Black board and Projector
4.		Forward channel in W-CDMA and CDMA 2000, reverse channels in W-CDMA and CDMA-2000.	1	Black board and Projector
5.		GPRS and higher data rates, short messaging service in GPRS mobile application protocols	1	Black board and Projector
6.		<b>Tutorial class</b>	1	Black board and Projector
7.		<b>Assignment</b>	1	Black board and Projector
8.		<b>Solving university Papers</b>	1	Black board and Projector
			<b>8</b>	
<b>Wireless LAN:</b>				
1.	UNIT VII	<b>Wireless LAN:</b>	1	Black board and Projector
2.		Historical overviews of the LAN industry,	1	Black board and Projector
3.		evolution of the LAN industry, wireless home networking	1	Black board and Projector
4.		IEEE 802.11 the PHY layer, MAC layer wireless	1	Black board and Projector

5.		ATM, Hyperlink, Hyper Lan-2	1	Black board and Projector
6.		<b>Virtual private Networks</b>	1	Black board and Projector
7.		<b>Tutorial class</b>	1	Black board and Projector
			<b>7</b>	
<b>Orthogonal frequency division multiplexing:</b>				
1.	<b>UNIT VIII</b>	<b>Orthogonal frequency division multiplexing:</b>	1	Black board and Projector
2.		basic principles of orthogonality single versus multi channel systems,	1	Black board and Projector
3.		OFDM block diagram, and its exokanatiion	1	Black board and Projector
4.		OFDM signal mathematical representation.	1	Black board and Projector
5.		Overview of OFDM	1	Black board and Projector
6.		<b>Tutorial class</b>	1	Black board and Projector
7.		<b>Assignment</b>	1	Black board and Projector
8.		<b>Solving university Papers</b>	1	Black board and Projector
9.			<b>8</b>	
<b>TOTAL</b>			<b>60</b>	



# Geethanjali College of Engineering & Technology

Cheeryal (v), Ranga Reddy (D) , Keesera (M), Hyderabad

## WIRELESS COMMUNICATION AND NETWORKS

### Lesson Schedule

Programme: B.Tech  
Year & Sem: IV -II Sem.  
Branch: ECE

Faculty Name: Mr. Y.SIVARAMAKRISHNA  
Asst. Professor  
Dept: ECE

S. No		Date	Topics to be covered	No. of lecture hrs required
<b>Introduction to wireless communication systems:</b>				
1	UNIT I	29/12/2014	<b>Introduction to wireless communication systems</b>	1
2		30/12/2014	evaluation of mobile radio communications	1
3		5/1/2015	examples of wireless communication systems	1
4		6/1/2015	paging systems, cordless telephone systems	1
5		7/1/2015	compression of various wireless systems	1
6		12/1/2015	<b>Tutorial class</b>	1
7		19/1/2015	<b>polling-Token Passing</b>	1
				7
<b>Mobile wireless communication systems,</b>				
8	UNIT II	20/1/2015	<b>Mobile wireless communication systems:</b>	1
9.		21/1/2015	second generation cellular networks	1
10.		27/1/2015	third generation wireless networks,	1
11.		28/1/2015	wireless in local loop, wireless local area networks	1
12.		2/2/2015	Bluetooth and personal area networks	1
13.		3/2/2015	<b>Tutorial class</b>	1
14.		4/2/2015	<b>Solving university Papers</b>	1
15.		9/2/2015	<b>Assignment</b>	1
				8

<b>Cellular system design fundamentals</b>				
16	UNIT III	10/2/2015	<b>Cellular system design fundamentals:</b> ,	1
17		11/2/2015	spectrum allocation, basic cellular system, frequency reuse	1
18		16/2/2015	channel assignment strategies, handoff strategies	1
19		17/2/2015	interference and system capacity, trucking and grade off service	1
20		18/2/2015	Improving coverage and capacity, cell splitting.	1
21		23/2/2015	<b>Tutorial class</b>	1
		24/2/2015	<b>Overview</b>	1
				<b>7</b>
<b>Multiple access technique for warless communications:</b>				
22	UNIT IV	25/2/2015	<b>Multiple access technique for warless communications</b>	1
23		2/3/2015	introduction to multiple accesses	1
24		3/3/2015	FDMA, TDMA	1
25		4/3/2015	spread spectrum multiple access, SDMA	1
26		9/3/2015	Packet radio, capacity of cellular systems.	1
27		10/3/2015	<b>Tutorial class</b>	1
28		11/3/2015	<b>Assignment</b>	1
29		16/3/2014	<b>Solving university Papers</b>	1
			<b>8</b>	
<b>Wireless Networking:</b>				
30	UNIT V	17/3/2015	Wireless Networking	1
31		18/3/2015	Difference between wireless and fixed telephone networks	1
32		23/3/2015	development of wireless networks, fixed network transmission hierarchy	1
33		24/3/2015	traffic routing in warless networks, wireless data services	1
34		25/3/2015	common channel signaling	1
35		01/4/2015	<b>Tutorial class</b>	1
36		6/4/2015	<b>Other IEEE 802.11 standards</b>	1

				<b>7</b>
<b>Wireless WAN</b>				
37	<b>UNIT VI</b>	<b>7/4/2015</b>	<b>Wireless WAN:</b> mechanism to support at mobile environment	1
38		<b>8/4/2015</b>	communication in the infrastructure , iIS-95 CDMA forward channel	1
39		<b>13/4/2015</b>	IS-95 CDMA risers channel, packet and frame formats in IS-95,IMT -20000	1
40		<b>14/4/2015</b>	Forward channel in W-CDMA and CDMA 2000, reverse channels in W-CDMA and CDMA -2000.	1
41		<b>15/4/2015</b>	GPRS and higher data rates, short messaging service in GPRS mobile application protocols	1
42		<b>15/4/2015</b>	<b>Tutorial class</b>	1
43		<b>15/4/2015</b>	<b>Assignment</b>	1
44		<b>15/4/2015</b>	<b>Solving university Papers</b>	1
				<b>8</b>
<b>Wireless lan:</b>				
45	<b>UNIT VII</b>	<b>20/4/2015</b>	<b>Wireless lan:</b>	1
46		<b>20/4/2015</b>	Historical overviews of the lan industry,	1
47		<b>20/4/2015</b>	evolution of the wan industry, wireless home networking	1
48		<b>21/4/2015</b>	IEEE 802.11 the PHY layer, Mac layer wireless	1
49		<b>21/4/2015</b>	ATM, Hyperlink, Hyper Lan-2	1
50		<b>21/4/2015</b>	<b>Virtual private Networks</b>	1
51		<b>22/4/2015</b>	<b>Tutorial class</b>	1
				<b>7</b>
<b>Orthogonal frequency division multiplexing:</b>				
52	<b>UNIT VIII</b>	<b>22/4/2015</b>	<b>Orthogonal frequency division multiplexing:</b>	1
53		<b>22/4/2015</b>	basic principles of orthogonality single versus multi channel systems,	1
54		<b>22/4/2015</b>	OFDM block diagram, and its exokanatiion	1
55		<b>27/4/2015</b>	OFDM signal mathematical representation.	1
56		<b>28/4/2015</b>	Overview of OFDM	1

57		28/4/2015	Tutorial class	1
58		29/4/2015	Assignment	1
59		29/4/2015	Solving university Papers	1
60				8
			<b>TOTAL</b>	<b><u>60</u></b>

HOD – E.C.E. Dept.

**GCCEFT**

## **14. Detailed notes:**

### **Unit-1**

#### **Introduction to wireless communication systems**

##### **1.1 Introduction**

Communication is one of the integral parts of science that has always been a focus point for exchanging information among parties at locations physically apart. After its discovery, telephones have replaced the telegrams and letters. Similarly, the term 'mobile' has completely revolutionized the communication by opening up innovative applications that are limited to one's imagination. Today, mobile communication has become the backbone of the society. All the mobile system technologies have improved the way of living. Its main plus point is that it has privileged a common mass of society. In this chapter, the evolution as well as the fundamental techniques of the mobile communication is discussed.

##### **1.2 Evolution of Mobile Radio Communications**

The first wireline telephone system was introduced in the year 1877. Mobile communication systems as early as 1934 were based on Amplitude Modulation (AM) schemes and only certain public organizations maintained such systems. With the demand for newer and better mobile radio communication systems during the World War II and the development of Frequency Modulation (FM) technique by Edwin Armstrong, the mobile radio communication systems began to witness many new changes. Mobile telephone was introduced in the year 1946. However, during its initial three and a half decades it found very less market penetration owing to high costs and numerous technological drawbacks. But with the development of the cellular concept in the 1960s at the Bell Laboratories, mobile communications began to be a promising field of expanse which could serve wider populations. Initially, mobile communication was restricted to certain official users and the cellular concept was never even dreamt of being made commercially available. Moreover, even the growth in the cellular networks was very slow. However, with the development of newer and better technologies starting from the 1970s and with the mobile users now connected to the Public Switched Telephone Network (PSTN), there has been an astronomical growth in the cellular radio and the personal communication systems. Advanced Mobile Phone System (AMPS) was the first U.S. cellular telephone system and it was deployed in 1983. Wireless services have since then been experiencing a 50% per year growth rate. The number of cellular telephone users grew from 25000 in 1984 to around 3 billion in the year 2007 and the demand rate is increasing day by day. A schematic of the subscribers is shown in Fig. 1.1

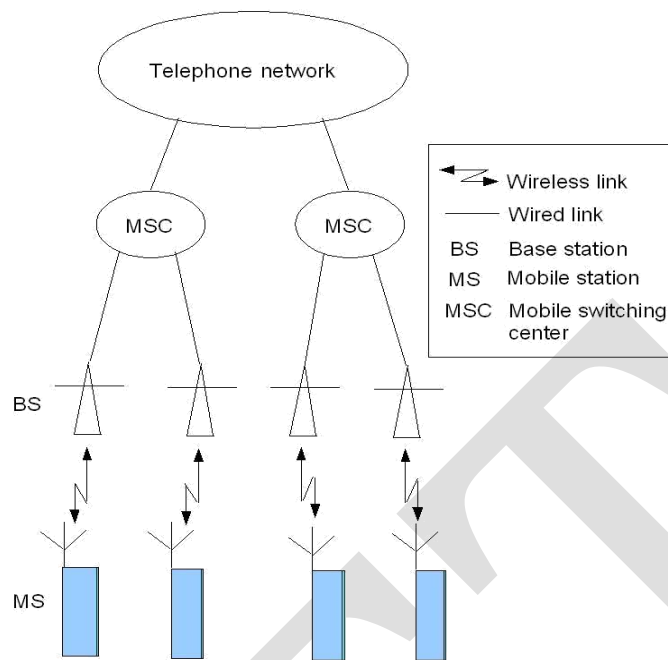

Figure 1.2: Basic mobile communication structure.

### 1.3 Present Day Mobile Communication

Since the time of wireless telegraphy, radio communication has been used extensively. Our society has been looking for acquiring mobility in communication since then. Initially the mobile communication was limited between one pair of users on single channel pair. The range of mobility was defined by the transmitter power, type of antenna used and the frequency of operation. With the increase in the number of users, accommodating them within the limited available frequency spectrum became a major problem. To resolve this problem, the concept of cellular communication was evolved. The present day cellular communication uses a basic unit called cell. Each cell consists of small hexagonal area with a base station located at the center of the cell which communicates with the user. To accommodate multiple users Time Division multiple Access (TDMA), Code Division Multiple Access (CDMA), Frequency Division Multiple Access (FDMA) and their hybrids are used. Numerous mobile radio standards have been deployed at various places such as AMPS, PACS, GSM, NTT, PHS and IS-95, each utilizing different set of frequencies and allocating different number of users and channels.

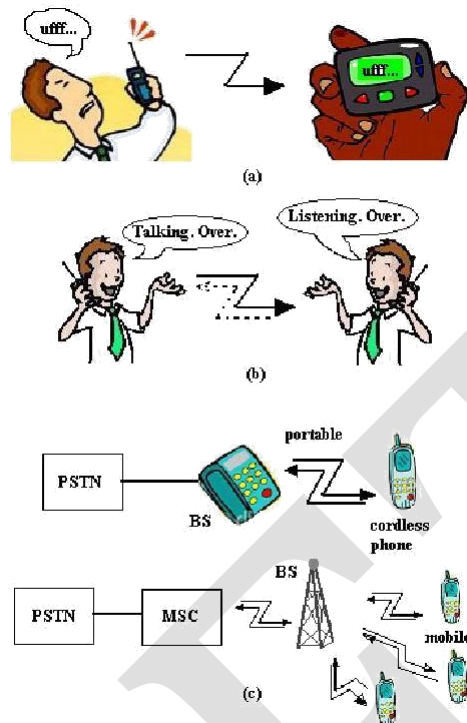

Figure 1.3: The basic radio transmission techniques: (a) simplex, (b) half duplex and (c) full duplex.

## 1.4 Fundamental Techniques

By definition, mobile radio terminal means any radio terminal that could be moved during its operation. Depending on the radio channel, there can be three different types of mobile communication. In general, however, a Mobile Station (MS) or subscriber unit communicates to a fixed Base Station (BS) which in turn communicates to the desired user at the other end. The MS consists of transceiver, control circuitry, duplexer and an antenna while the BS consists of transceiver and channel multiplexer along with antennas mounted on the tower. The BS are also linked to a power source for the transmission of the radio signals for communication and are connected to a fixed backbone network. Figure 1.2 shows a basic mobile communication with low power transmitters/receivers at the BS, the MS and also the Mobile Switching Center (MSC). The MSC is sometimes also called Mobile Telephone Switching Office (MTSO). The radio signals emitted by the BS decay as the signals travel away from it. A minimum amount of signal strength is needed in order to be detected by the mobile stations or mobile sets which are the hand-held personal units (portables) or those installed in the vehicles (mobiles). The region over which the signal strength lies above such a threshold value is known as the coverage area of a BS. The fixed backbone network is a

wired network that links all the base stations and also the landline and other telephone networks through wires.

### 1.4.1 Radio Transmission Techniques

Based on the type of channels being utilized, mobile radio transmission systems may be classified as the following three categories which is also shown in Fig. 1.3:

**Simplex System:** Simplex systems utilize simplex channels i.e., the communication is unidirectional. The first user can communicate with the second user. However, the second user cannot communicate with the first user. One example of such a system is a pager.

**Half Duplex System:** Half duplex radio systems that use half duplex radio channels allow for non-simultaneous bidirectional communication. The first user can communicate with the second user but the second user can communicate to the first user only after the first user has finished his conversation. At a time, the user can only transmit or receive information. A walkie-talkie is an example of a half duplex system which uses 'push to talk' and 'release to listen' type of switches.

**Full Duplex System:** Full duplex systems allow two way simultaneous communications. Both the users can communicate to each other simultaneously. This can be done by providing two simultaneous but separate channels to both the users. This is possible by one of the two following methods.

**Frequency Division Duplexing (FDD):** FDD supports two-way radio communication by using two distinct radio channels. One frequency channel is transmitted downstream from the BS to the MS (forward channel).

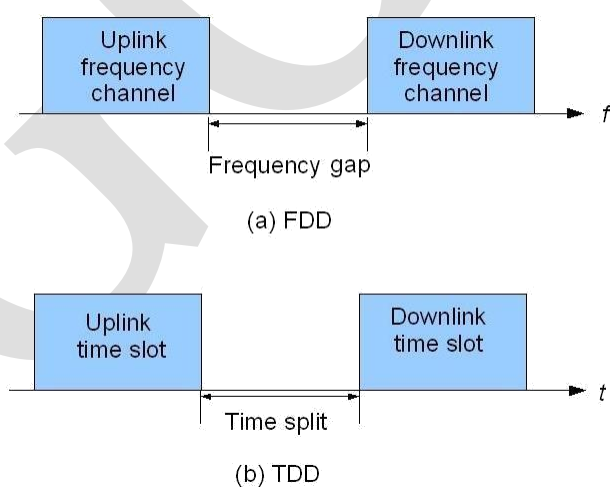

Figure 1.4: (a) Frequency division duplexing and (b) time division duplexing.



A second frequency is used in the upstream direction and supports trans-mission from the MS to the BS (reverse channel). Because of the pairing of frequencies, simultaneous transmission in both directions is possible. To mitigate self-interference between upstream and downstream transmissions, a minimum amount of frequency separation must be maintained between the frequency pair, as shown in Fig. 1.4.

Time Division Duplexing (TDD): TDD uses a single frequency band to transmit signals in both the downstream and upstream directions. TDD operates by toggling transmission directions over a time interval. This toggling takes place very rapidly and is imperceptible to the user.

A full duplex mobile system can further be subdivided into two category: a single MS for a dedicated BS, and many MS for a single BS. Cordless telephone systems are full duplex communication systems that use radio to connect to a portable handset to a single dedicated BS, which is then connected to a dedicated telephone line with a speci c telephone number on the Public Switched Telephone Network (PSTN). A mobile system, in general, on the other hand, is the example of the second category of a full duplex mobile system where many users connect among themselves via a single BS.

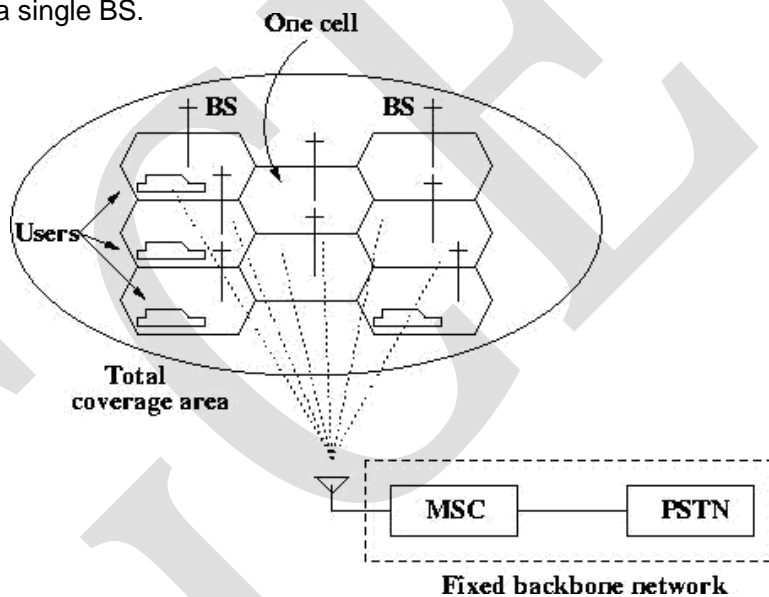

Figure 1.5: Basic Cellular Structure.

## 1.5 How a Mobile Call is Actually Made?

In order to know how a mobile call is made, we should first look into the basics of cellular concept and main operational channels involved in making a call. These are given below.

### 1.5.1 Cellular Concept

Cellular telephone systems must accommodate a large number of users over a large geographic area with limited frequency spectrum, i.e., with limited number of channels. If a single transmitter/ receiver is used with only a single base station, then sufficient amount of power may not be present at a huge distance from the BS. For a large geographic coverage area, a high powered transmitter therefore has to be used. But a high power radio transmitter causes harm to environment. Mobile communication thus calls for replacing the high power transmitters by low power transmitters by dividing the coverage area into small segments, called cells. Each cell uses a certain number of the available channels and a group of adjacent cells together use all the available channels. Such a group is called a cluster. This cluster can repeat itself and hence the same set of channels can be used again and again. Each cell has a low power transmitter with a coverage area equal to the area of the also sends the MIN of the person to whom the call has to be made. The MSC then sends this MIN to all the base stations. The base station transmits this MIN and all the mobiles within the coverage area of that base station receive the MIN and match it with their own. If the MIN matches with a particular MS, that mobile sends an acknowledgment to the BS. The BS then informs the MSC that the mobile is within its coverage area. The MSC then instructs the base station to access specific unused voice channel pair. The base station then sends a message to the mobile to move to the particular channels and it also sends a signal to the mobile for ringing.

In order to maintain the quality of the call, the MSC adjusts the transmitted power of the mobile which is usually expressed in dB or dBm. When a mobile moves from the coverage area of one base station to the coverage area of another base station i.e., from one cell to another cell, then the signal strength of the initial base station may not be sufficient to continue the call in progress. So the call has to be transferred to the other base station. This is called handoff . In such cases, in order to maintain the call, the MSC transfers the call to one of the unused voice channels of the new base station or it transfers the control of the current voice channels to the new base station.

Ex. 1: Suppose a mobile unit transmits 10 W power at a certain place. Express this power in terms of dBm.

Solution: Usually, 1 mW power developed over a 100 load is equivalently called 0 dBm power.

1 W is equivalent to 0 dB, i.e.,  $10 \log_{10}(1W) = 0\text{dB}$ .

Thus,  $1W = 10^3\text{mW} = 30\text{dBm} = 0\text{dB}$ .

This means,  $x\text{dB} = (x + 30)\text{dBm}$ .

Hence,  $10W = 10 \log_{10}(10W) = 10\text{dB} = 40\text{dBm}$ .

Ex. 2: Among a pager, a cordless phone and a mobile phone, which device would have the

(i) Shortest and (ii) longest battery life? Justify.

Solution: The `pager' would have the longest and the `mobile phone' would have the shortest battery life.

(Justification is left on the readers)

## 1.6 Future Trends

Tremendous changes are occurring in the area of mobile radio communications, so much so that the mobile phone of yesterday is rapidly turning into a sophisticated mobile device capable of more applications than PCs were capable of only a few years ago. Rapid development of the Internet with its new services and applications has created fresh challenges for the further development of mobile communication systems. Further enhancements in modulation schemes will soon increase the In-ternet access rates on the mobile from current 1.8 Mbps to greater than 10 Mbps. Bluetooth is rapidly becoming a common feature in mobiles for local connections.

The mobile communication has provided global connectivity to the people at a lower cost due to advances in the technology and also because of the growing competition among the service providers. We would review certain major features as well as standards of the mobile communication till the present day technology in the next chapter.

## 1.7 References

1. T. S. Rappaport, Wireless Communications: Principles and Practice, 2nd ed. Singapore: Pearson Education, Inc., 2002.
  2. K. Feher, Wireless Digital Communications: Modulation and Spread Spectrum Applications. Upper Saddle River, NJ: Prentice Hall, 1995.
- J. G. Proakis, Digital Communications, 4th ed. NY: McGraw Hill, 2000.

# UNIT 2

## Modern Wireless Communication Systems

At the initial phase, mobile communication was restricted to certain official users and the cellular concept was never even dreamt of being made commercially available. Moreover, even the growth in the cellular networks was very slow. However, with the development of newer and better technologies starting from the 1970s and with the mobile users now connected to the PSTN, there has been a remarkable growth in the cellular radio. However, the spread of mobile communication was very fast in the 1990s when the government throughout the world provided radio spectrum licenses for Personal Communication Service (PCS) in 1.8 - 2 GHz frequency band.

### 2.1 1G: First Generation Networks

The first mobile phone system in the market was AMPS. It was the first U.S. cellular telephone system, deployed in Chicago in 1983. The main technology of this first generation mobile system was FDMA/FDD and analog FM.

### 2.2 2G: Second Generation Networks

Digital modulation formats were introduced in this generation with the main technology as TDMA/FDD and CDMA/FDD. The 2G systems introduced three popular TDMA standards and one popular CDMA standard in the market. These are as follows:

#### 2.2.1 TDMA/FDD Standards

(a) Global System for Mobile (GSM): The GSM standard, introduced by Groupe Special Mobile, was aimed at designing a uniform pan-European mobile system. It was the first fully digital system utilizing the 900 MHz frequency band. The initial GSM had 200 KHz radio channels, 8 full-rate or 16 half-rate TDMA channels per carrier, encryption of speech, low speed data services and support for SMS for which it gained quick popularity.

(b) Interim Standard 136 (IS-136): It was popularly known as North American Digital Cellular (NADC) system. In this system, there were 3 full-rate TDMA users over each 30 KHz channel. The need of this system was mainly to increase the capacity over the earlier analog (AMPS) system.

(c) Pacific Digital Cellular (PDC): This standard was developed as the counter-part of NADC in Japan. The main advantage of this standard was its low transmission bit rate which led to its better spectrum utilization.

### 2.2.2 CDMA/FDD Standard

Interim Standard 95 (IS-95): The IS-95 standard, also popularly known as CDMA-One, uses 64 orthogonally coded users and code words are transmitted simultaneously on each of 1.25 MHz channels. Certain services that have been standardized as a part of IS-95 standard are: short messaging service, slotted paging, over-the-air activation (meaning the mobile can be activated by the service provider without any third party intervention), enhanced mobile station identities etc.

### 2.2.3 2.5G Mobile Networks

In an effort to retrofit the 2G standards for compatibility with increased throughput rates to support modern Internet application, the new data centric standards were developed to be overlaid on 2G standards and this is known as 2.5G standard.

Here, the main up gradation techniques are:

Supporting higher data rate transmission for web browsing

Supporting e-mail traffic

Enabling location-based mobile service

2.5G networks also brought into the market some popular application, a few of which are: Wireless Application Protocol (WAP), General Packet Radio Service (GPRS), High Speed Circuit Switched Data (HSCSD), Enhanced Data rates for GSM Evolution (EDGE) etc.

## 2.3 3G: Third Generation Networks

3G is the third generation of mobile phone standards and technology, superseding 2.5G. It is based on the International Telecommunication Union (ITU) family of standards under the International Mobile Telecommunications-2000 (IMT-2000). ITU launched IMT-2000 program, which, together with the main industry and standardization bodies worldwide, targets to implement a global frequency band that would support a single, ubiquitous wireless communication standard for all countries, to provide the framework for the definition of the 3G mobile systems. Several radio access technologies have been accepted by ITU as part of the IMT-2000 frame-work.

3G networks enable network operators to offer users a wider range of more advanced services while achieving greater network capacity through improved spectral efficiency. Services include wide-area wireless voice telephony, video calls, and broad-band wireless data, all in a mobile environment. Additional features

also include HSPA data transmission capabilities able to deliver speeds up to 14.4Mbit/s on the down link and 5.8Mbit/s on the uplink.

3G networks are wide area cellular telephone networks which evolved to incorporate high-speed internet access and video telephony. IMT-2000 defines a set of technical requirements for the realization of such targets, which can be summarized as follows:

High data rates: 144 kbps in all environments and 2 Mbps in low-mobility and indoor environments  
symmetrical and asymmetrical data transmission

Circuit-switched and packet-switched-based services speech quality comparable to wire-line quality improved  
spectral efficiency

Several simultaneous services to end users for multimedia services seamless incorporation of second-generation cellular systems

Global roaming

Open architecture for the rapid introduction of new services and technology.

### 2.3.1 3G Standards and Access Technologies

As mentioned before, there are several different radio access technologies defined within ITU, based on either CDMA or TDMA technology. An organization called 3rd Generation Partnership Project (3GPP) has continued that work by defining a mobile system that fulfills the IMT-2000 standard. This system is called Universal Mobile Telecommunications System (UMTS). After trying to establish a single 3G standard, ITU finally approved a family of five 3G standards, which are part of the 3G framework known as IMT-2000:

W-CDMA CDMA2000 TD-SCDMA

Europe, Japan, and Asia have agreed upon a 3G standard called the Universal Mobile Telecommunications System (UMTS), which is WCDMA operating at 2.1 GHz. UMTS and WCDMA are often used as synonyms. In the USA and other parts of America, WCDMA will have to use another part of the radio spectrum.

### 2.3.2 3G W-CDMA (UMTS)

WCDMA is based on DS-SS-SS-SS (direct sequence code division multiple access) technology in which user-information bits are spread over a wide bandwidth (much larger than the information signal bandwidth) by multiplying the user data with the spreading code. The chip (symbol rate) rate of the spreading sequence is 3.84 Mcps, which, in the WCDMA system deployment is used together with the 5-MHz carrier spacing. The

processing gain term refers to the relationship between the signal bandwidth and the information bandwidth. Thus, the name wideband is derived to differentiate it from the 2G CDMA (IS-95), which has a chip rate of 1.2288 Mcps. In a CDMA system, all users are active at the same time on the same frequency and are separated from each other with the use of user specific spreading codes.

The wide carrier bandwidth of WCDMA allows supporting high user-data rates and also has certain performance benefits, such as increased multipath diversity. The actual carrier spacing to be used by the operator may vary on a 200-kHz grid between approximately 4.4 and 5 MHz, depending on spectrum arrangement and the interference situation.

In WCDMA each user is allocated frames of 10 ms duration, during which the user-data rate is kept constant. However, the data rate among the users can change from frame to frame. This fast radio capacity allocation (or the limits for variation in the uplink) is controlled and coordinated by the radio resource management (RRM) functions in the network to achieve optimum throughput for packet data services and to ensure sufficient quality of service (QoS) for circuit-switched users. WCDMA supports two basic modes of operation: FDD and TDD. In the FDD mode, separate 5-MHz carrier frequencies with duplex spacing are used for the uplink and downlink, respectively, whereas in TDD only one 5-MHz carrier is time shared between the up-link and the downlink. WCDMA uses coherent detection based on the pilot symbols and/or common pilot. WCDMA allows many performance- enhancement methods to be used, such as transmit diversity or advanced CDMA receiver concepts. Table summarizes the main WCDMA parameters.

The support for handovers (HO) between GSM and WCDMA is part of the first standard version. This means that all multi-mode WCDMA/GSM terminals will support measurements from the one system while camped on the other one. This allows networks using both WCDMA and GSM to balance the load between the networks and base the HO on actual measurements from the terminals for different radio conditions in addition to other criteria available.

Table 2.1: Main WCDMA parameters

Multiple access method	DS-CDMA
Duplexing method	Frequency division duplex/time division Duplex
Base station synchronization	Asynchronous operation
Chip rate	3.84 Mcps
Frame length	10 ms
Service multiplexing	Multiple services with different quality of service requirements multiplexed on one

Multi-rate concept	Connection
Detection	Variable spreading factor and multicode
Multi-user detection, smart antennas	Coherent using pilot symbols or common Pilot
	Supported by the standard, optional in the Implementation

The world's first commercial W-CDMA service, FoMA, was launched by NTT DoCoMo in Japan in 2001. FoMA is the short name for Freedom of Mobile Multimedia Access, is the brand name for the 3G services being offered by Japanese mobile phone operator NTT DoCoMo. Elsewhere, W-CDMA deployments have been exclusively UMTS based.

UMTS or W-CDMA, assures backward compatibility with the second generation GSM, IS-136 and PDC TDMA technologies, as well as all 2.5G TDMA technologies. The network structure and bit level packaging of GSM data is retained by W-CDMA, with additional capacity and bandwidth provided by a new CDMA air interface.

### 2.3.3 3G CDMA2000

Code division multiple access 2000 is the natural evolution of IS-95 (cdma One). It includes additional functionality that increases its spectral efficiency and data rate capability. (code division multiple access) is a mobile digital radio technology where channels are defined with codes (PN sequences). CDMA permits many simultaneous transmitters on the same frequency channel. Since more phones can be served by fewer cell sites, CDMA-based standards have a significant economic advantage over TDMA- or FDMA-based standards. This standard is being developed by Telecommunications Industry Association (TIA) of US and is standardized by 3GPP2.

The main CDMA2000 standards are: CDMA2000 1xRTT, CDMA 2000 1xEV and CDMA2000 EV-DV. These are the approved radio interfaces for the ITU's IMT-2000 standard. In the following, a brief discussion about all these standards is given.

CDMA2000 1xRTT: RTT stands for Radio Transmission Technology and the designation "1x", meaning "1 times Radio Transmission Technology", indicates the same RF bandwidth as IS-95. The main features of CDMA2000 1X are as follows:

Supports an instantaneous data rate up to 307kbps for a user in packet mode and a typical throughput rates of 144kbps per user, depending on the number of user, the velocity of user and the propagating conditions.

Supports up to twice as many voice users as the 2G CDMA standard provides the subscriber unit with up to two times the standby time for longer lasting battery life.



CDMA2000 EV: This is an evolutionary advancement of CDMA with the following characteristics:

Provides CDMA carriers with the option of installing radio channels with data only (CDMA2000 EV-DO) and with data and voice (CDMA2000 EV-DV) .

The cdma2000 1xEV-DO supports greater than 2.4Mbps of instantaneous high-speed packet throughput per user on a CDMA channel, although the user data rates are much lower and highly dependent on other factors.

CDMA2000 EV-DV can offer data rates up to 144kbps with about twice as many voice channels as IS-95B.

CDMA2000 3x is (also known as EV-DO Rev B) is a multi-carrier evolution.

It has higher rates per carrier (up to 4.9 Mbit /s on the downlink per carrier). Typical deployments are expected to include 3 carriers for a peak rate of 14.7 Mbit /s. Higher rates are possible by bundling multiple channels together. It enhances the user experience and enables new services such as high definition

Video streaming

Uses statistical multiplexing across channels to further reduce latency, enhancing the experience for latency-sensitive services such as gaming, video telephony, remote console sessions and web browsing.

It provides increased talk-time and standby time.

The interference from the adjacent sectors is reduced by hybrid frequency re-use and improves the rates that can be offered, especially to users at the edge of the cell.

It has efficient support for services that have asymmetric download and upload requirements (i.e. different data rates required in each direction) such as file transfers, web browsing, and broadband multimedia content delivery.

#### 2.3.4 3G TD-SCDMA

Time Division-Synchronous Code Division Multiple Access, or TD-SCDMA, is a 3G mobile telecommunications standard, being pursued in the People's Republic of China by the Chinese Academy of Telecommunications Technology (CATT). This proposal was adopted by ITU as one of the 3G options in late 1999. TD-SCDMA is based on spread spectrum technology.

TD-SCDMA uses TDD, in contrast to the FDD scheme used by W-CDMA. By dynamically adjusting the number of timeslots used for downlink and uplink, the system can more easily accommodate asymmetric traffic with different data rate requirements on downlink and uplink than FDD schemes. Since it does not require paired spectrum for downlink and uplink, spectrum allocation flexibility is also increased. Also, using the same carrier frequency for uplink and downlink means that the channel condition is the same on both directions, and

the base station can deduce the downlink channel information from uplink channel estimates, which is helpful to the application of beam forming techniques.

TD-SCDMA also uses TDMA in addition to the CDMA used in WCDMA. This reduces the number of users in each timeslot, which reduces the implementation complexity of multiuser detection and beam forming schemes, but the non-continuous transmission also reduces coverage (because of the higher peak power needed), mobility (because of lower power control frequency) and complicates radio resource management algorithms.

The "S" in TD-SCDMA stands for "synchronous", which means that uplink signals are synchronized at the base station receiver, achieved by continuous timing adjustments. This reduces the interference between users of the same timeslot using different codes by improving the orthogonality between the codes, therefore increasing system capacity, at the cost of some hardware complexity in achieving uplink synchronization.

## 2.4 Wireless Transmission Protocols

There are several transmission protocols in wireless manner to achieve different application oriented tasks. Below, some of these applications are given.

### 2.4.1 Wireless Local Loop (WLL) and LMDS

Microwave wireless links can be used to create a wireless local loop. The local loop can be thought of as the "last mile" of the telecommunication network that resides between the central office (CO) and the individual homes and business in close proximity to the CO. An advantage of WLL technology is that once the wireless equipment is paid for, there are no additional costs for transport between the CO and the customer premises equipment. Many new services have been proposed and this includes the concept of Local Multipoint Distribution Service (LMDS), which provides broadband telecommunication access in the local exchange.

### 2.4.2 Bluetooth

Facilitates ad-hoc data transmission over short distances from fixed and mobile devices as shown in Figure 2.1

Uses a radio technology called frequency hopping spread spectrum. It chops up the data being sent and transmits chunks of it on up to 79 different frequencies.

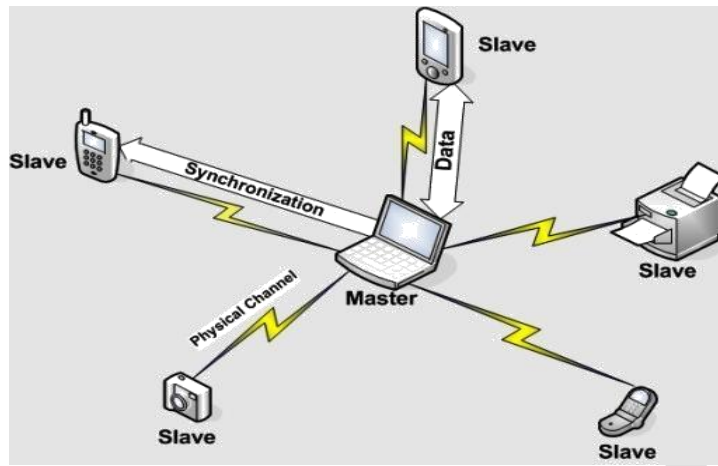

Figure 2.1: Data transmission with Bluetooth.

In its basic mode, the modulation is Gaussian frequency shift keying (GFSK). It can achieve a gross data rate of 1 Mb/s

Primarily designed for low power consumption, with a short range (power-class-dependent: 1 meter, 10 meters, 100 meters) based on low-cost transceiver microchips in each device

#### 2.4.3 Wireless Local Area Networks (W-LAN)

IEEE 802.11 WLAN uses ISM band (5.275-5.825GHz)

Uses 11Mcps DS-SS spreading and 2Mbps user data rates (will fallback to 1Mbps in noisy conditions)

IEEE 802.11a standard provides up to 54Mbps throughput in the 5GHz band. The DS-SS IEEE 802.11b has been called Wi-Fi. Wi-Fi networks have limited range. A typical Wi-Fi home router using 802.11b or 802.11g with a stock antenna might have a range of 32 m (120 ft) indoors and 95 m (300 ft) outdoors. Range also varies with frequency band.

IEEE 802.11g uses Complementary Code Keying Orthogonal Frequency Division Multiplexing (CCK-OFDM) standards in both 2.4GHz and 5GHz bands.

#### 2.4.4 WiMax

Provides upto 70 Mb/sec symmetric broadband speed without the need for cables. The technology is based on the IEEE 802.16 standard (also called WirelessMAN)

WiMAX can provide broadband wireless access (BWA) up to 30 miles (50 km) for fixed stations, and 3 - 10 miles (5 - 15 km) for mobile stations. In contrast, the WiFi/802.11 wireless local area network standard is limited in most cases to only 100 - 300 feet (30 - 100m)

The 802.16 specification applies across a wide range of the RF spectrum, and WiMAX could function on any frequency below 66 GHz (higher frequencies would decrease the range of a Base Station to a few hundred meters in an urban environment).

#### 2.4.5 Zigbee

ZigBee is the specification for a suite of high level communication protocols using small, low-power digital radios based on the IEEE 802.15.4-2006 standard for wireless personal area networks (WPANs), such as wireless headphones connecting with cell phones via short-range radio.

This technology is intended to be simpler and cheaper. ZigBee is targeted at radio-frequency (RF) applications that require a low data rate, long battery life, and secure networking.

ZigBee operates in the industrial, scientific and medical (ISM) radio bands; 868 MHz in Europe, 915 MHz in countries such as USA and Australia, and 2.4 GHz in most worldwide.

#### 2.4.6 Wibree

Wibree is a digital radio technology (intended to become an open standard of wireless communications) designed for ultra low power consumption (button cell batteries) within a short range (10 meters / 30 ft) based around low-cost transceiver microchips in each device. Wibree is known as Bluetooth with low energy technology.

It operates in 2.4 GHz ISM band with physical layer bit rate of 1 Mbps.

### 2.5 Conclusion: Beyond 3G Networks

Beyond 3G networks, or 4G (Fourth Generation), represent the next complete evolution in wireless communications. A 4G system will be able to provide a comprehensive IP solution where voice, data and streamed multimedia can be given to users at higher data rates than previous generations. There is no formal definition for 4G ; however, there are certain objectives that are projected for 4G. It will be capable of providing between 100 Mbit/s and 1 Gbit/s speeds both indoors and outdoors, with premium quality and high security. It would also support systems like multicarrier communication, MIMO and UWB.

### 2.6 References

1. T. S. Rappaport, Wireless Communications: Principles and Practice, 2nd ed. Singapore: Pearson Education, Inc., 2002.

2. W. C. Lee, Mobile Communications Engineering, 2nd ed. New Delhi: Tata McGraw-Hill, 2008.

R. Pandya, Mobile and Personal Communication Systems and Services, 4th ed. New Delhi: PHI, 2004.

## Chapter 3

# The Cellular Engineering Fundamentals

### 3.1 Introduction

In Chapter 1, we have seen that the technique of substituting a single high power transmitter by several low power transmitters to support many users is the backbone of the cellular concept. In practice, the following four parameters are most important while considering the cellular issues: system capacity, quality of service, spectrum efficiency and power management. Starting from the basic notion of a cell, we would deal with these parameters in the context of cellular engineering in this chapter.

### 3.2 What is a Cell?

The power of the radio signals transmitted by the BS decay as the signals travel away from it. A minimum amount of signal strength (let us say,  $x$  dB) is needed in order to be detected by the MS or mobile sets which may be the hand-held personal units or those installed in the vehicles. The region over which the signal strength lies above this threshold value  $x$  dB is known as the coverage area of a BS and it must be a circular region, considering the BS to be isotropic radiator. Such a circle, which gives this actual radio coverage, is called the foot print of a cell (in reality, it is amorphous). It might so happen that either there may be an overlap between any two such side by side circles or there might be a gap between the coverage areas of two adjacent circles. This is shown in Figure 3.1. Such a circular geometry, therefore, cannot serve as a regular shape to describe cells. We need a regular shape for cellular design over a territory which can be served by 3 regular polygons, namely, equilateral triangle, square and regular hexagon, which can cover the entire area without any overlap and gaps.

Along with its regularity, a cell must be designed such that it is most reliable too, i.e., it supports even the weakest mobile with occurs at the edges of the cell. For any distance between the center and the farthest point in the cell from it, a regular hexagon covers the maximum area. Hence regular hexagonal geometry is used as the cells in mobile communication.

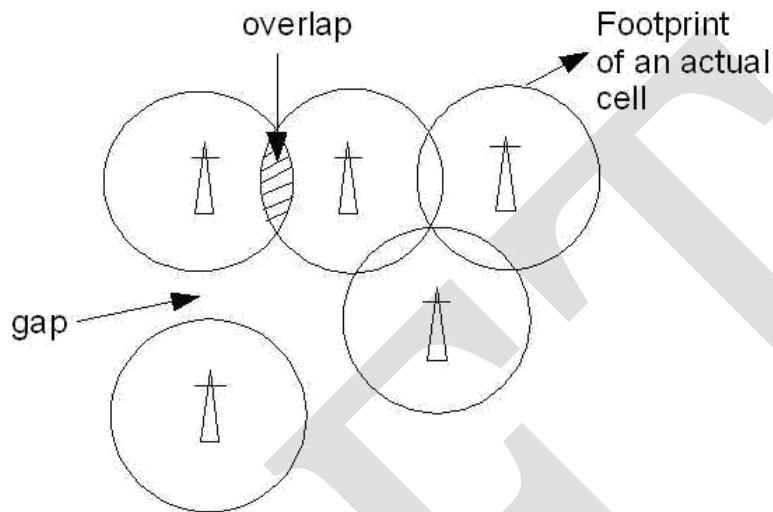

Figure 3.1: Footprint of cells showing the overlaps and gaps.

### 3.3 Frequency Reuse

Frequency reuse, or, frequency planning, is a technique of reusing frequencies and channels within a communication system to improve capacity and spectral efficiency. Frequency reuse is one of the fundamental concepts on which commercial wireless systems are based that involve the partitioning of an RF radiating area into cells. The increased capacity in a commercial wireless network, compared with a network with a single transmitter, comes from the fact that the same radio frequency can be reused in a different area for a completely different transmission.

Frequency reuse in mobile cellular systems means that frequencies allocated to the service are reused in a regular pattern of cells, each covered by one base station. The repeating regular pattern of cells is called cluster. Since each cell is designed to use radio frequencies only within its boundaries, the same frequencies can be reused in other cells not far away without interference, in another cluster. Such cells are called 'co-channel' cells. The reuse of frequencies enables a cellular system to handle a huge number of calls with a limited number of channels. Figure 3.2 shows a frequency planning with cluster size of 7, showing the co-channels cells in different clusters by the same letter. The closest distance between the co-channel cells (in different clusters) is determined by the choice of the cluster size and the layout of the cell cluster. Consider a cellular system with  $S$  duplex channels available for use and let  $N$  be the number of cells in a cluster. If each cell is allotted  $K$  duplex channels with all being allotted unique

and disjoint channel groups we have  $S = KN$  under normal circumstances. Now, if the cluster are repeated  $M$  times within the total area, the total number of duplex channels, or, the total number of users in the system would be  $T = MS = KMN$ . Clearly, if  $K$  and  $N$  remain constant, then

$$T / M \tag{3.1}$$

and, if  $T$  and  $K$  remain constant, then

$$N / \frac{1}{M} : \tag{3.2}$$

Hence the capacity gain achieved is directly proportional to the number of times a cluster is repeated, as shown in (3.1), as well as, for a fixed cell size, small  $N$

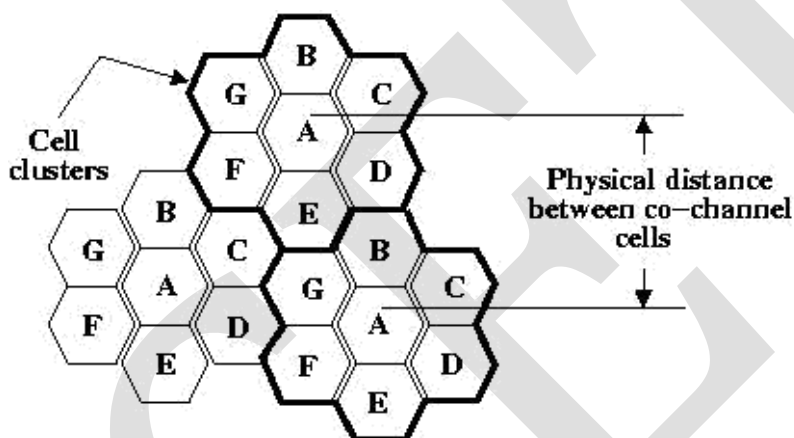

Figure 3.2: Frequency reuse technique of a cellular system.

decreases the size of the cluster with in turn results in the increase of the number of clusters (3.2) and hence the capacity. However for small  $N$ , co-channel cells are located much closer and hence more interference. The value of  $N$  is determined by calculating the amount of interference that can be tolerated for a sufficient quality communication. Hence the smallest  $N$  having interference below the tolerated limit is used. However, the cluster size  $N$  cannot take on any value and is given only by the following equation

$$N = i^2 + ij + j^2; \quad i \geq 0; j \geq 0; \tag{3.3}$$

Where  $i$  and  $j$  are integer numbers.

## 3.4 Channel Assignment Strategies

With the rapid increase in number of mobile users, the mobile service providers had to follow strategies which ensure the effective utilization of the limited radio spectrum. With increased capacity and low interference being the prime objectives, a frequency reuse scheme was helpful in achieving these objectives. A variety of channel assignment strategies have been followed to aid these objectives. Channel assignment strategies are classified into two types: fixed and dynamic, as discussed below.

### 3.4.1 Fixed Channel Assignment (FCA)

In fixed channel assignment strategy each cell is allocated a fixed number of voice channels. Any communication within the cell can only be made with the designated unused channels of that particular cell. Suppose if all the channels are occupied, then the call is blocked and subscriber has to wait. This is simplest of the channel assignment strategies as it requires very simple circuitry but provides worst channel utilization. Later there was another approach in which the channels were borrowed from adjacent cell if all of its own designated channels were occupied. This was named as borrowing strategy. In such cases the MSC supervises the borrowing process and ensures that none of the calls in progress are interrupted.

### 3.4.2 Dynamic Channel Assignment (DCA)

In dynamic channel assignment strategy channels are temporarily assigned for use in cells for the duration of the call. Each time a call attempt is made from a cell the corresponding BS requests a channel from MSC. The MSC then allocates a channel to the requesting the BS. After the call is over the channel is returned and kept in a central pool. To avoid co-channel interference any channel that in use in one cell can only be reassigned simultaneously to another cell in the system if the distance between the two cells is larger than minimum reuse distance. When compared to the FCA, DCA has reduced the likelihood of blocking and even increased the trunking capacity of the network as all of the channels are available to all cells, i.e., good quality of service. But this type of assignment strategy results in heavy load on switching center at heavy traffic condition.

## 3.5 Handoff Process

When a user moves from one cell to the other, to keep the communication between the user pair, the user channel has to be shifted from one BS to the other without interrupting the call, i.e., when a MS moves into another cell, while the conversation is still in progress, the MSC automatically transfers the call to a new FDD channel without disturbing the conversation. This process is called as handoff. A schematic diagram of handoff is given in Figure 3.3.



Processing of handoff is an important task in any cellular system. Handoffs must be performed successfully and be imperceptible to the users. Once a signal level is set as the minimum acceptable for good voice quality ( $P_{rmin}$ ), then a slightly stronger level is chosen as the threshold ( $P_{rH}$ ) at which handoff has to be made, as shown in Figure 3.4. A parameter, called power margin, defined as

$$= P_{rH} - P_{rmin} \quad (3.7)$$

is quite an important parameter during the handoff process since this margin can neither be too large nor too small. If it is too small, then there may not be enough time to complete the handoff and the call might be lost even if the user crosses the cell boundary.

If it is too high on the other hand, then MSC has to be burdened with unnecessary handoffs. This is because MS may not intend to enter the other cell. Therefore it should be judiciously chosen to ensure imperceptible handoffs and to meet other objectives.

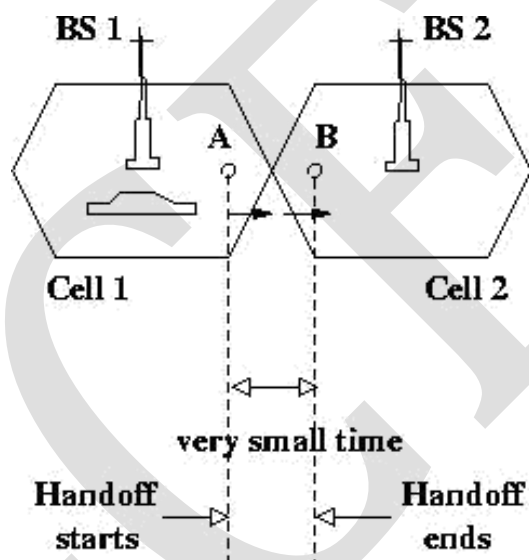
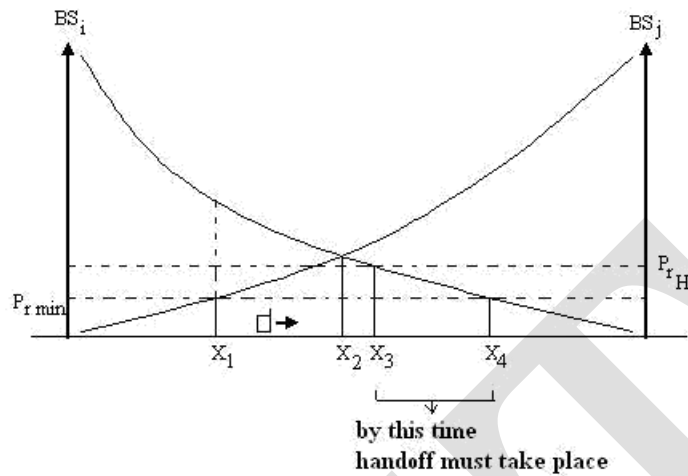

Figure 3.3: Handoff scenario at two adjacent cell boundaries.

### 6.8.1 Factors Influencing Handoffs

The following factors influence the entire handoff process:

- (a) Transmitted power: as we know that the transmission power is different for different cells, the handoff threshold or the power margin varies from cell to cell.
- (b) Received power: the received power mostly depends on the Line of Sight (LOS) path between the user and the BS. Especially when the user is on the boundary of



$BS_i$  = Base station of  $i$ th cell  
 $BS_j$  = Base station of any adjacent  $j$ th cell

Figure 3.4: Handoff process associated with power levels, when the user is going from  $i$ -th cell to  $j$ -th cell.

the two cells, the LOS path plays a critical role in handoffs and therefore the power margin depends on the minimum received power value from cell to cell.

(c) Area and shape of the cell: Apart from the power levels, the cell structure also plays an important role in the handoff process.

(d) Mobility of users: The number of mobile users entering or going out of a particular cell, also fixes the handoff strategy of a cell.

To illustrate the reasons (c) and (d), let us consider a rectangular cell with sides  $R_1$  and  $R_2$  inclined at an angle with horizon, as shown in the Figure 3.5. Assume  $N_1$  users are having handoff in horizontal direction and  $N_2$  in vertical direction per unit length.

The number of crossings along  $R_1$  side is :  $(N_1 \cos + N_2 \sin) R_1$  and the number of crossings along  $R_2$  side is :  $(N_1 \sin + N_2 \cos) R_2$ .

Then the handoff rate  $H$  can be written as

$$H = (N_1 \cos + N_2 \sin) R_1 + (N_1 \sin + N_2 \cos) R_2 \quad (3.8)$$

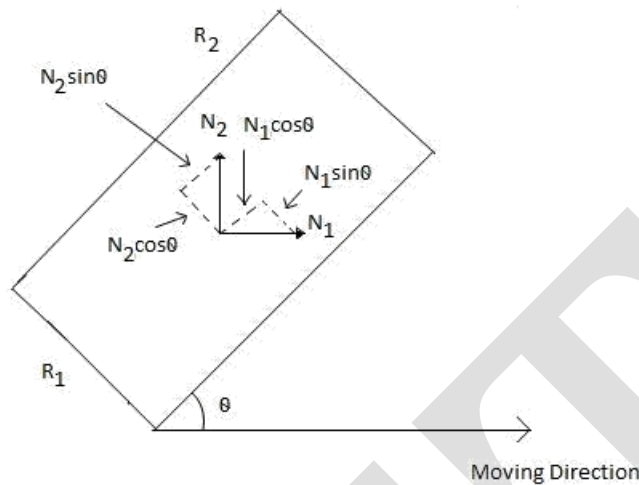

Figure 3.5: Handoff process with a rectangular cell inclined at an angle  $\theta$ .

Now, given the fixed area  $A = R_1 R_2$ , we need to find  $\min_H$  for a given  $\theta$ . Replacing  $R_1$  by  $\frac{A}{R_2}$  and equating  $\frac{dH}{dR_1}$  to zero, we get

$$R_1^2 = A \left( \frac{N_1 \sin \theta + N_2 \cos \theta}{N_1 \cos \theta + N_2 \sin \theta} \right) \quad (3.9)$$

Similarly, for  $R_2$ , we get

$$R_2^2 = A \left( \frac{N_1 \cos \theta + N_2 \sin \theta}{N_1 \sin \theta + N_2 \cos \theta} \right) \quad (3.10)$$

From the above equations, we have  $H = 2 \sqrt{A(N_1 N_2 + (N_1^2 + N_2^2) \cos \theta \sin \theta)}$  which means it is minimized at  $\theta = 0^\circ$ . Hence  $\min_H = 2 \sqrt{A N_1 N_2}$ . Putting the value of

in (3.9) or (3.10), we have  $\frac{R_1}{R_2} = \frac{N_1}{N_2}$ . This has two implications: (i) that handoff is

minimized if rectangular cell is aligned with X-Y axis, i.e.,  $\theta = 0^\circ$ , and, (ii) that the number of users crossing the cell boundary is inversely proportional to the dimension of the other side of the cell. The above analysis has been carried out for a simple square cell and it changes in more complicated way when we consider a hexagonal cell.

### 3.5.2 Handoffs In Different Generations

In 1G analog cellular system, the signal strength measurements were made by the BS and in turn supervised by the MSC. The handoffs in this generation can be termed as Network Controlled Hand-Off (NCHO). The BS monitors the signal strengths of voice channels to determine the relative positions of the

subscriber. The special receivers located on the BS are controlled by the MSC to monitor the signal strengths of the users in the neighboring cells which appear to be in need of handoff. Based on the information received from the special receivers the MSC decides whether a handoff is required or not. The approximate time needed to make a handoff successful was about 5-10 s. This requires the value of  $\Delta P$  to be in the order of 6dB to 12dB.

In the 2G systems, the MSC was relieved from the entire operation. In this generation, which started using the digital technology, handoff decisions were mobile assisted and therefore it is called Mobile Assisted Hand-Off (MAHO). In MAHO, the mobile center measures the power changes received from nearby base stations and notifies the two BS. Accordingly the two BS communicate and channel transfer occurs. As compared to 1G, the circuit complexity was increased here whereas the delay in handoff was reduced to 1-5 s. The value of  $\Delta P$  was in the order of 0-5 dB. However, even this amount of delay could create a communication pause.

In the current 3G systems, the MS measures the power from adjacent BS and automatically upgrades the channels to its nearer BS. Hence this can be termed as Mobile Controlled Hand-Off (MCHO). When compared to the other generations, delay during handoff is only 100 ms and the value of  $\Delta P$  is around 20 dBm. The Quality Of Service (QOS) has improved a lot although the complexity of the circuitry has further increased which is inevitable.

All these types of handoffs are usually termed as hard handoff as there is a shift in the channels involved. There is also another kind of handoff, called soft handoff as discussed below.

Handoff in CDMA: In spread spectrum cellular systems, the mobiles share the same channels in every cell. The MSC evaluates the signal strengths received from different BS for a single user and then shifts the user from one BS to the other without actually changing the channel. These types of handoffs are called as soft handoff as there is no change in the channel.

### 3.5.3 Handoff Priority

While assigning channels using either FCA or DCA strategy, a guard channel concept must be followed to facilitate the handoffs. This means, a fraction of total available channels must be kept for handoff requests. But this would reduce the carried traffic and only fewer channels can be assigned for the residual users of a cell. A good solution to avoid such a dead-lock is to use DCA with handoff priority (demand based allocation).

### 3.5.4 A Few Practical Problems in Handoff Scenario

3.5.4 Different speed of mobile users: with the increase of mobile users in urban areas, microcells are introduced in the cells to increase the capacity (this will be discussed later in this chapter). The users with high speed frequently crossing the micro-cells become burdened to MSC as it has to take care of Handoff Priority

While assigning channels using either FCA or DCA strategy, a guard channel concept must be followed to

facilitate the handoffs. This means, a fraction of total available channels must be kept for handoff requests. But this would reduce the carried traffic and only fewer channels can be assigned for the residual users of a cell. A good solution to avoid such a dead-lock is to use DCA with handoff priority (demand based allocation).

### 3.5.5 A Few Practical Problems in Handoff Scenario

3.5.5 Different speed of mobile users: with the increase of mobile users in urban areas, microcells are introduced in the cells to increase the capacity (this will be discussed later in this chapter). The users with high speed frequently crossing the micro-cells become burdened to MSC as it has to take care of Handoff Priority

While assigning channels using either FCA or DCA strategy, a guard channel concept must be followed to facilitate the handoffs. This means, a fraction of total available channels must be kept for handoff requests. But this would reduce the carried traffic and only fewer channels can be assigned for the residual users of a cell. A good solution to avoid such a dead-lock is to use DCA with handoff priority (demand based allocation).

### 3.5.6 A Few Practical Problems in Handoff Scenario

(a) Different speed of mobile users: with the increase of mobile users in urban areas, microcells are introduced in the cells to increase the capacity (this will be discussed later in this chapter). The users with high speed frequently crossing the micro-cells become burdened to MSC as it has to take care of handoffs. Several schemes thus have been designed to handle the simultaneous traffic of high speed and low speed users while minimizing the handoff intervention from the MSC, one of them being the 'Umbrella Cell' approach. This technique provides large area coverage to high speed users while providing small area coverage to users traveling at low speed. By using different antenna heights and different power levels, it is possible to provide larger and smaller cells at a same location. As illustrated in the Figure 3.6, umbrella cell is co-located with few other microcells. The BS can measure the speed of the user by its short term average signal strength over the RVC and decides which cell to handle that call. If the speed is less, then the corresponding microcell handles the call so that there is good corner coverage. This approach assures that handoffs are minimized for high speed users and provides additional microcell channels for pedestrian users.

(b) Cell dragging problem: this is another practical problem in the urban area with additional microcells. For example, consider there is a LOS path between the MS and BS1 while the user is in the cell covered by BS2. Since there is a LOS with the BS1, the signal strength received from BS1 would be greater than that received from BS2. However, since the user is in cell covered by BS2, handoff cannot take place and as a result, it experiences a lot of interferences. This problem can be solved by judiciously choosing the handoff threshold along with adjusting the coverage areas. Several schemes thus have been designed to handle the simultaneous traffic of high speed and low speed users while minimizing the handoff intervention from the MSC, one of them being the 'Umbrella Cell'

approach. This technique provides large area coverage to high speed users while providing small area coverage to users traveling at low speed. By using different antenna heights and different power levels, it is possible to provide larger and smaller cells at a same location. As illustrated in the Figure 3.6, umbrella cell is co-located with few other microcells. The BS can measure the speed of the user by its short term average signal strength over the RVC and decides which cell to handle that call. If the speed is less, then the corresponding microcell handles the call so that there is good corner coverage. This approach assures that handoffs are minimized for high speed users and provides additional microcell channels for pedestrian users.

(c) Cell dragging problem: this is another practical problem in the urban area with additional microcells. For example, consider there is a LOS path between the MS and BS1 while the user is in the cell covered by BS2. Since there is a LOS with the BS1, the signal strength received from BS1 would be greater than that received from BS2. However, since the user is in cell covered by BS2, handoff cannot take place and as a result, it experiences a lot of interferences. This problem can be solved by judiciously choosing the handoff threshold along with adjusting the coverage areas. Several schemes thus have been designed to handle the simultaneous traffic of high speed and low speed users while minimizing the handoff intervention from the MSC, one of them being the 'Umbrella Cell' approach. This technique provides large area coverage to high speed users while providing small area coverage to users traveling at low speed. By using different antenna heights and different power levels, it is possible to provide larger and smaller cells at a same location. As illustrated in the Figure 3.6, umbrella cell is co-located with few other microcells. The BS can measure the speed of the user by its short term average signal strength over the RVC and decides which cell to handle that call. If the speed is less, then the corresponding microcell handles the call so that there is good corner coverage. This approach assures that handoffs are minimized for high speed users and provides additional microcell channels for pedestrian users.

Cell dragging problem: this is another practical problem in the urban area with additional microcells. For example, consider there is a LOS path between the MS and BS1 while the user is in the cell covered by BS2. Since there is a LOS with the BS1, the signal strength received from BS1 would be greater than that received from BS2. However, since the user is in cell covered by BS2, handoff cannot take place and as a result, it experiences a lot of interferences. This problem can be solved by judiciously choosing the handoff threshold along with adjusting the coverage area

## UNIT - 4

### Techniques for Wireless Communications

Multiple access schemes are used to allow many mobile users to share simultaneously a finite amount of radio spectrum. The sharing of spectrum is required to achieve high capacity by simultaneously allocating the available bandwidth (or the available amount of channels) to multiple users. For high quality communications, this must be done without severe degradation in the performance of the system.

#### Introduction

In wireless communications systems, it is desirable to allow the subscriber to send simultaneously information to the base station while receiving information from the base station. For example, in conventional telephone systems, it is possible to talk and listen simultaneously, and this effect, called **duplexing**, is generally required in wireless telephone systems. Duplexing may be done using frequency or time domain techniques. **Frequency division duplexing** (FDD) provides two distinct bands of frequencies for every user. The forward band provides traffic from the base station to the mobile, and the reverse band provides traffic from the mobile to the base. In FDD, any **duplex channel** actually consists of two simplex channels, and a device called a **duplexer** is used inside each subscriber unit and base station to allow simultaneous radio transmission and reception on the duplex channel pair. The frequency split between the forward and reverse channel is constant throughout the system, regardless of the particular channel being used. **Time division duplexing** (TDD) uses time instead of frequency to provide both a forward and reverse link. If the time split between the forward and reverse time slot is small, then the transmission and reception of data appears simultaneous to the user. Figure 8.1 illustrates FDD and TDD techniques. TDD allows communication on a single channel (as opposed to requiring two simplex or dedicated channels) and simplifies the subscriber equipment since a duplexer is not required.

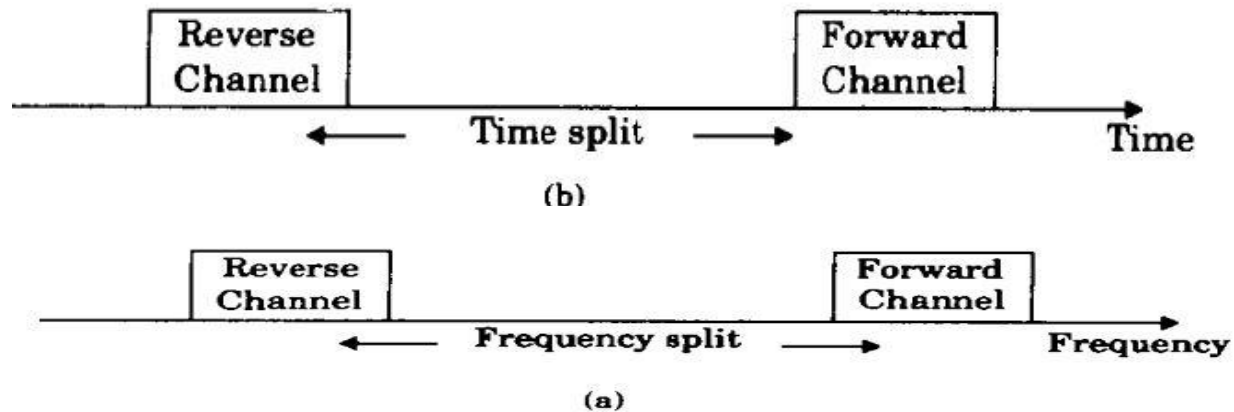

Figure 4.1 (a) FDD provides two simplex channels at the same time.

**(b) TDD provides two simplex time slots on the same frequency.**

There are several trade-offs between FDD and TDD approaches. FDD is geared toward radio communications systems that provide individual radio frequencies for each user. Because each transceiver simultaneously transmits and receives radio signals which vary by more than 100 dB, the frequency allocation used for the forward and reverse channels must be carefully coordinated with out-of-band users that occupy spectrum between these two bands. Furthermore, the frequency separation must be coordinated to permit the use of inexpensive RF technology. TDD enables each transceiver to operate as either a transmitter or receiver on the same frequency, and eliminates the need for separate forward and reverse frequency bands. However, there is a time latency due to the fact that communications is not full duplex in the truest sense.

**Introduction to Multiple Accesses:**

Frequency division multiple access (FDMA), time division multiple access (TDMA), and code division multiple access (CDMA) are the three major access techniques used to share the available bandwidth in a wireless communication system. These techniques can be grouped as narrowband and wideband systems, depending upon how the available bandwidth is allocated to the users. The duplexing technique of a multiple access system is usually described along with



the particular multiple access scheme, as shown in the examples below.

## **1.Narrowband Systems:**

The term narrow band is used to relate the bandwidth of a single channel to the expected coherence bandwidth of the channel. In a narrowband multiple access system, the available radio spectrum is divided into a large number of narrowband channels. The channels are usually operated using FDD. To minimize interference between forward and reverse links on each channel, the frequency split is made as great as possible within the frequency spectrum, while still allowing inexpensive duplexers and a common transceiver antenna to be used in each subscriber unit. In narrowband FDMA, a user is assigned a particular channel which is not shared by other users in the vicinity, and if FDD is used (that is, each channel has a forward and reverse link), then the system is called FDMA/FDD. Narrowband TDMA, on the other hand, allows users to share the same channel but allocates a unique time slot to each user in a cyclical fashion on the channel, thus separating a small number of users in time on a single channel. For narrowband TDMA, there generally are a large number of channels allocated using either FDD or TDD, and each channel is shared using TDMA. Such systems are called TDMA/FDD or TDMA/FDD access systems.

## **Wideband systems:**

In wideband systems, the transmission bandwidth of a single channel is much larger than the coherence bandwidth of the channel. Thus, multipath fading does not greatly affect the received signal within a wideband channel, and frequency selective fades occur in only a small fraction of the signal bandwidth.

In wideband multiple access systems, the users are allowed to transmit in a large part of the spectrum. A large number of transmitters are also allowed to transmit on the same channel.

TDMA allocates time slots to the many transmitters on the same channel and

allows only one transmitter to access the channel at any instant of time, whereas spread spectrum CDMA allows all of the transmitters to access the channel at the same time. TDMA and CDMA systems may use either FDD or TDD multiplexing techniques.

In addition to FDMA, TDMA, and CDMA, two other multiple access schemes are used for wireless communications. These are packet radio (PR) and space division multiple access (SDMA). Table 8.1 shows the different multiple access techniques being used in various wireless communications systems.

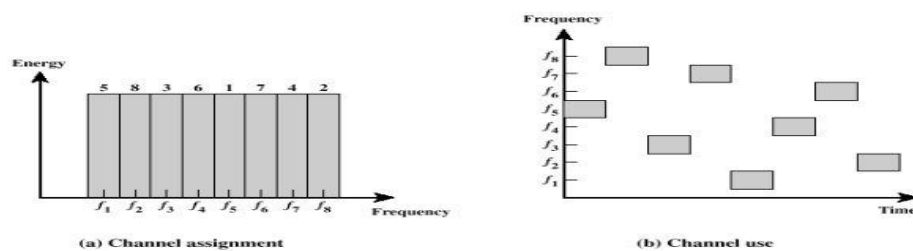

Figure 7.2 Frequency Hopping Example

## Drawbacks of CDMA Cellular

- Self-jamming – arriving transmissions from multiple users not aligned on chip boundaries unless users are perfectly synchronized
- Near-far problem – signals closer to the receiver are received with less attenuation than signals farther away
- Soft handoff – requires that the mobile acquires the new cell before it relinquishes the old; this is more complex than hard handoff used in FDMA and TDMA schemes

## 2 Frequency Division Multiple Access (FDMA)

Frequency division multiple access (FDMA) assigns individual channels to individual users. It can be seen from Figure 8.2 that each user is allocated a unique frequency band or channel. These channels are assigned on demand to users who request service. During the period of the call, no other user can share the same frequency band. In FDD systems, the users are assigned a channel as a pair of frequencies; one frequency is used for the forward channel, while the other frequency is used for the reverse channel. The features of FDMA are as follows:

**Table: Multiple Access Techniques Used in Different Wireless Communication Systems**

Multiple Access Cellular System	Technique
Advanced Mobile Phone System (AMPS)	FDMA/FDD
Global System for Mobile (GSM)	TDMA/FDD
U.S. Digital Cellular (USDC)	TDMA/TDD
Japanese Digital Cellular (JDC)	TDMA/FDD
CT2 (Cordless Telephone)	FDMA/TDD
Digital European Cordless Telephone (DECT)	FDMA/TDD
U.S. Narrowband Spread Spectrum (IS-95)	CDMA/FDD

- The FDMA channel carries only one phone circuit at a time.
- If an FDMA channel is not in use, then it sits idle and cannot be used by other users to increase or share capacity. It is essentially a wasted resource.
- After the assignment of a voice channel, the base station and the mobile transmit simultaneously and continuously.
- The bandwidths of FDMA channels are relatively narrow (30 kHz) as each channel supports only one circuit per carrier. That is, FDMA is usually implemented in narrowband systems.

- FDMA requires tight RF filtering to minimize adjacent channel interference.
- The FDMA mobile unit uses duplexers since both the transmitter and receiver operate at the same time. This results in an increase in the cost of FDMA subscriber units and base stations.
- The symbol time is large as compared to the average delay spread. This implies that the amount of intersymbol interference is low and, thus, little or no equalization is required in FDMA narrowband systems.
- The complexity of FDMA mobile systems is lower when compared to TDMA systems, though this is changing as digital signal processing methods improve for TDMA.
- Since FDMA is a continuous transmission scheme, fewer bits are needed for overhead purposes (such as synchronization and framing bits) as compared to TDMA.
- FDMA systems have higher cell site system costs as compared to TDMA systems, because of the single channel per carrier design, and the need to use costly bandpass filters to eliminate spurious radiation at the base station.

### **Nonlinear Effects in FDMA:**

In a FDMA system, many channels share the same antenna at the base station. The power amplifiers or the power combiners, when operated at or near saturation for maximum power efficiency, are non-linear. The nonlinearities cause signal spreading in the frequency domain and generate inter modulation (IM) frequencies. IM is undesired RF radiation which can interfere with other channels in the FDMA systems. Spreading of the spectrum results in adjacent-channel interference. Inter modulation is the generation of undesirable harmonics. Harmonics generated outside the mobile radio band cause interference to adjacent services, while those present inside the band cause interference to other users in the mobile system.

### **Example 1**

Find the inter modulation frequencies generated if a base station transmits two carrier frequencies at 1930 MHz and 1932 MHz that are amplified by a saturated clipping amplifier. If the mobile radio band is allocated from 1920 MHz to 1940 MHz, designate the 1M frequencies that lie inside and outside the band.

## Solution

Inter modulation distortion products occur at frequencies  $m f_1 + n f_2$  for all integer values of  $m$  and  $n$ , i.e.,  $- \infty < m, n < \infty$ . Some of the possible inter modulation frequencies that are produced by a nonlinear device are

$$(2n + 1)f_1 - 2nf_2, (2n + 2)f_1 - (2n + 1)f_2, (2n + 1)f_1 - 2nf_2, \\ (2n + 2)f_2 - (2n + 1)f_1, \text{ etc.} \quad \text{for } n = 0, 1, 2, \dots$$

Table E8.1 lists several inter modulation product terms.

Table E 8.1: Inter modulation Products

n=0	n=1	n=2	n=3
1930	1926	1922	1918
1928	1924	1920	1916
1932	1936	1940	1944*
1934	1938	1942*	1946*

The frequencies in the table marked with an asterisk (\*) are the frequencies that lie outside the mobile radio band.

The first U.S. analog cellular system, the **Advanced Mobile Phone System** (AMPS), is based on FDMA/FDD. A single user occupies a single channel while the call is in progress, and the single channel is actually two simplex channels which are frequency duplexed with a 45 MHz split. When a call is completed, or when a handoff occurs, the channel is vacated so that another mobile subscriber may use it. Multiple or simultaneous users are accommodated in AMPS by giving each user a unique channel. Voice signals are sent on the forward channel from the base station to mobile unit, and on the reverse channel from the mobile unit to the base station. In AMPS, analog narrowband frequency modulation (NBFM) is used to modulate the carrier. The number of channels that can be simultaneously supported in a FDMA system is given by

$$N = \frac{B_t - 2B_{guard}}{B_c} \quad (8.1)$$

where  $B_t$  is the total spectrum allocation,  $B_{guard}$  is the guard band allocated at the edge of the allocated spectrum, and  $B_c$  is the channel bandwidth.

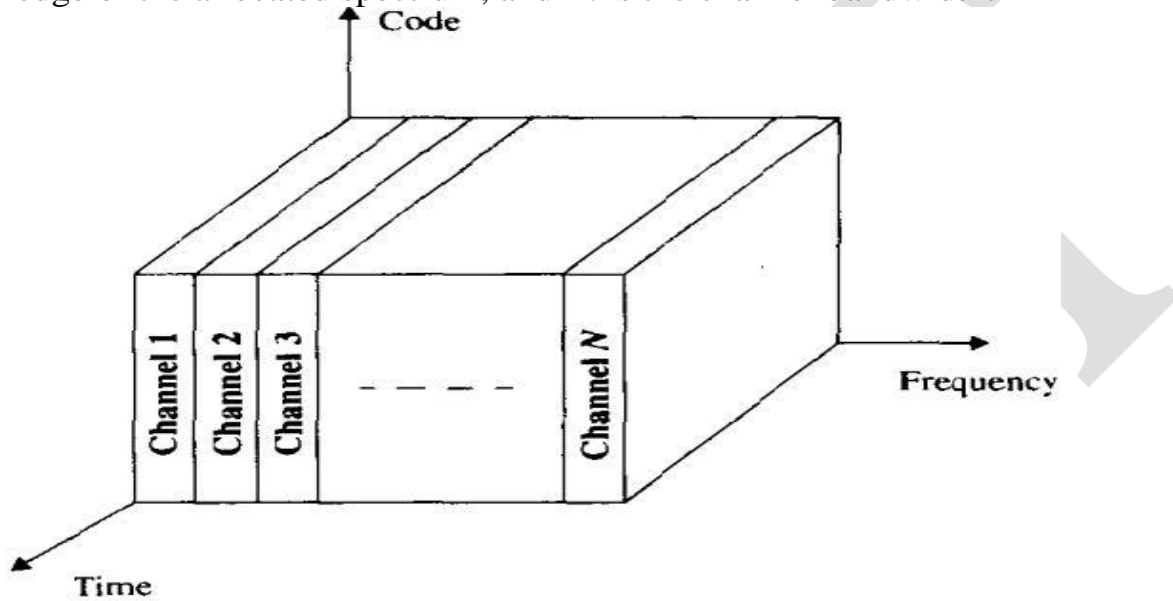

Figure 4.2 FDMA where different channels are assigned different frequency bands

**Example 2**

If  $B_t$  is 12.5 MHz,  $B_{guard}$  is 10 kHz, and  $B_c$  is 30 kHz, find the number of channels available in an FDMA system.

**Solution**

The number of channels available in the FDMA system is given as

$$N = \frac{12.5 \times 10^6 - 2(10 \times 10^3)}{30 \times 10^3} = 416$$

In the U.S., each cellular carrier is allocated 416 channels

## Time Division Multiple Access (TDMA)

Time division multiple access (TDMA) systems divide the radio spectrum into time slots, and in each slot only one user is allowed to either transmit or receive. It can be seen from Figure 8.3 that each user occupies a cyclically repeating time slot, so a channel may be thought of as particular time slot that reoccurs every frame, where  $N$  time slots comprise a frame. TDMA systems transmit data in a buffer-and-burst method, thus the transmission for any user is noncontinuous. This implies that, unlike in FDMA systems which accommodate analog FM, digital data and digital modulation must be used with TDMA. The transmission from various users is interlaced into a repeating frame structure as shown in Figure 8.4. It can be seen that a frame consists of a number of slots. Each frame is made up of a preamble, an information message, and tail bits. In TDMA/TDD, half of the time slots in the frame information message would be used for the forward link channels and half would be used for reverse link channels. In TDMA/FDD systems, an identical or similar frame structure would be used solely for either forward or reverse transmission, but the carrier frequencies would be different for the forward and reverse links. In general, TDMA/FDD systems intentionally induce several time slots of delay between the forward and reverse time slots of a particular user, so that duplexers are not required in the subscriber unit.

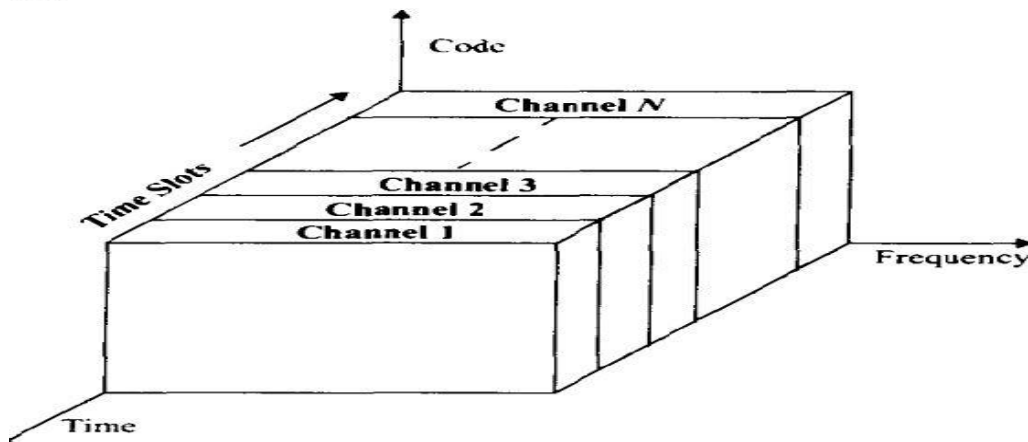

**Figure 4.3 TDMA scheme where each channel occupies a cyclically repeating time slot.**

In a TDMA frame, the preamble contains the address and synchronization information that both the base station and the subscribers use to identify each other. Guard times are utilized to allow synchronization of the receivers between different slots and frames. Different TDMA wireless standards have different TDMA frame structures, and some

are described in Chapter 10. The features of TDMA include the following:

- TDMA shares a single carrier frequency with several users, where each user makes use of nonoverlapping time slots. The number of time slots per frame depends on several factors, such as modulation technique, available bandwidth, etc.
- Data transmission for users of a TDMA system is not continuous, but occurs in bursts. This results in low battery consumption, since the subscriber transmitter can be turned off when not in use (which is most of the time).
- Because of discontinuous transmissions in TDMA, the handoff process is much simpler for a subscriber unit, since it is able to listen for other base stations during idle time slots. An enhanced link control, such as that provided by mobile assisted handoff (MAHO) can be carried out by a subscriber by listening on an idle slot in the TDMA frame
- TDMA uses different time slots for transmission and reception, thus duplexers are not required. Even if FDD is used, a switch rather than a duplexer inside the subscriber unit is all that is required to switch between transmitter and receiver using TDMA.
- Adaptive equalization is usually necessary in TDMA systems, since the transmission rates are generally very high as compared to FDMA channels
- In TDMA, the guard time should be minimized. If the transmitted signal at the edges of a time slot are suppressed sharply in order to shorten the guard time, the transmitted spectrum will expand and cause interference to adjacent channels.
- High synchronization overhead is required in TDMA systems because of burst transmissions. TDMA transmissions are slotted, and this requires the receivers to be synchronized for each data burst. In addition, guard slots are necessary to separate users, and this results in the TDMA systems having larger overheads as compared to FDMA.
- TDMA has an advantage in that it is possible to allocate different numbers of time slots per frame to different users. Thus bandwidth can be supplied on demand to different users by concatenating or reassigning time slots based



on priority.

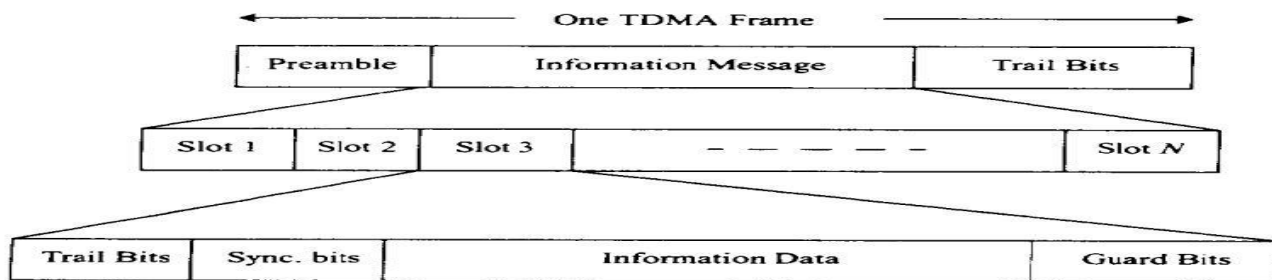

Figure 4.4 TDMA frame structure.

**Efficiency of TDMA** - The efficiency of a TDMA system is a measure of the percentage of transmitted data that contains information as opposed to providing overhead for the access scheme. The frame efficiency,  $\eta_f$ , is the percentage of bits per frame which contain transmitted data. Note that the transmitted data may include source and channel coding bits, so the raw end-user efficiency of a system is generally less than  $\eta_f$ . The frame efficiency can be found as follows.

The number of overhead bits per frame is

$$b_{OH} = N_r b_r + N_t b_p + N_t b_g + N_r b_g \quad (8.2)$$

where,  $N_r$ , is the number of reference bursts per frame,  $N_t$  is the number of traffic bursts per frame,  $b_r$  is the number of overhead bits per reference burst,  $b_p$  is the number of overhead bits per preamble in each slot, and  $b_g$  is the number of equivalent bits in each guard time interval. The total number of bits per frame,  $b_T$ , is

$$b_T = T_f R \quad (8.3)$$

where  $T_f$  is the frame duration, and  $R$  is the channel bit rate. The frame efficiency  $\eta_f$  is thus given as

$$\eta_f = \left( 1 - \frac{b_{OH}}{b_T} \right) \times 100\% \quad (8.4)$$

**Number of channels in TDMA system** - The number of TDMA channel slots that can be provided in a TDMA system is found by multiplying the number of TDMA slots per channel by the number of channels available and is given by

$$N = \frac{m (B_{tot} - 2B_{guard})}{B_c} \quad (8.5)$$

where  $m$  is the maximum number of TDMA users supported on each radio channel. Note that two guard bands, one at the low end of the allocated frequency band and one at the high end, are required to ensure that users at the edge of the band do not "bleed over" into an adjacent radio service.

### Example 3

Consider Global System for Mobile, which is a TDMA/FDD system that uses 25 MHz for the forward link, which is broken into radio channels of 200 kHz. If 8 speech channels are supported on a single radio channel, and if no guard band is assumed, find the number of simultaneous users that can be accommodated in GSM.

### Solution

The number of simultaneous users that can be accommodated in GSM is given as

$$N = \frac{25 \text{ MHz}}{\frac{(200 \text{ kHz})}{8}}$$

Thus, GSM can accommodate 1000 simultaneous users.

### Example 4

If GSM uses a frame structure where each frame consists of 8 time slots, and each time slot contains 156.25 bits, and data is transmitted at 270.833 kbps in the channel, find (a) the time duration of a bit, (b) the time duration of a slot, (c) the time duration of a frame, and (d) how long must a user occupying a single time slot must wait between two simultaneous transmissions.

(a) The time duration of a bit,  $T_b = \frac{1}{270.833 \text{ kbps}} = 3.692 \mu\text{s}$ .

(b) The time duration of a slot,  $T_{slot} = 156.25 \times T_b = 0.577 \text{ ms}$ .

(c) The time duration of a frame,  $T_f = 8 \times T_{slot} = 4.615 \text{ ms}$ .

(d) A user has to wait 4.615 ms, the arrival time of a new frame, for its next transmission.

- **Spread Spectrum Multiple Access**

Spread spectrum multiple access (SSMA) uses signals which have a trans-

mission bandwidth that is several orders of magnitude greater than the minimum required RF bandwidth. A pseudo-noise (PN) sequence converts a narrowband signal to a wideband noise-like signal before transmission. SSMA also provides immunity to multipath interference and robust multiple access capability. SSMA is not very bandwidth efficient when used by a single user. However, since many users can share the same spread spectrum bandwidth without interfering with one another, spread spectrum systems become bandwidth efficient in a multiple user environment. It is exactly this situation that is of interest to wireless system designers. There are two main types of spread spectrum multiple access techniques; frequency hopped multiple access (FH) and direct sequence multiple access (DS). Direct sequence multiple access is also called code division multiple access (CDMA).

### **1. Frequency Hopped Multiple Access (FHMA)**

Frequency hopped multiple access (FHMA) is a digital multiple access system in which the carrier frequencies of the individual users are varied in a pseudo-random fashion within a wideband channel. The digital data is broken into uniform sized bursts which are transmitted on different carrier frequencies. The instantaneous bandwidth of any one transmission burst is much smaller than the total spread bandwidth. The pseudo-random change of the carrier frequencies of the user randomizes the occupancy of a specific channel at any given time, thereby allowing for multiple access over a wide range of frequencies. In the FH receiver, a locally generated PN code is used to synchronize the receiver's instantaneous frequency with that of the transmitter. At any given point in time, a frequency hopped signal only occupies a single, relatively narrow channel since narrowband FM or FSK is used.

The difference between FHMA and a traditional FDMA system is that the frequency hopped signal changes channels at rapid intervals. If the rate of change of the carrier frequency is greater than the symbol rate then the system is referred to as a fast frequency hopping system. If the channel changes at a rate less than or equal to the symbol rate, it is called slow frequency hopping. A fast frequency hopper may thus be thought of as an FDMA system which employs frequency diversity. FHMA systems often employ energy efficient constant envelope modulation. Inexpensive receivers may be built to provide noncoherent detection of FHMA. This implies that linearity is not an issue, and the power of multiple users at the receiver does not degrade FHMA performance.

A frequency hopped system provides a level of security especially when a large number of channels are used, since an unintended (or an intercepting) receiver that does not know the pseudorandom sequence of frequency slots must retune rapidly to search for the signal it wishes to intercept. In addition, the FH signal is somewhat immune to fading, since error control coding and interleaving can be used to protect the frequency hopped signal against deep fades which may occasionally occur during the hopping sequence. Error control coding and interleaving can also be combined to guard against erasures which can occur when two or more users transmit on the same channel at the same time.

## 2 Code Division Multiple Access (CDMA)

In code division multiple access (CDMA) systems, the narrowband message signal is multiplied by a very large bandwidth signal called the spreading signal. The spreading signal is a pseudo-noise code sequence that has a chip rate which is orders of magnitudes greater than the data rate of the message. All users in a CDMA system, as seen from Figure 8.5, use the same carrier frequency and may transmit simultaneously. Each user has its own pseudorandom codeword which is approximately orthogonal to all other codewords.

The receiver performs a time correlation operation to detect only the specific desired codeword. All other codewords appear as noise due to decorrelation. For detection of the message signal, the receiver needs to know the codeword used by the transmitter. Each user operates independently with no knowledge of the other users,

In CDMA, the power of multiple users at a receiver determines the noise floor after decorrelation. If the power of each user within a cell is not controlled such that they do not appear equal at the base station receiver, then the **near-far problem** occurs.

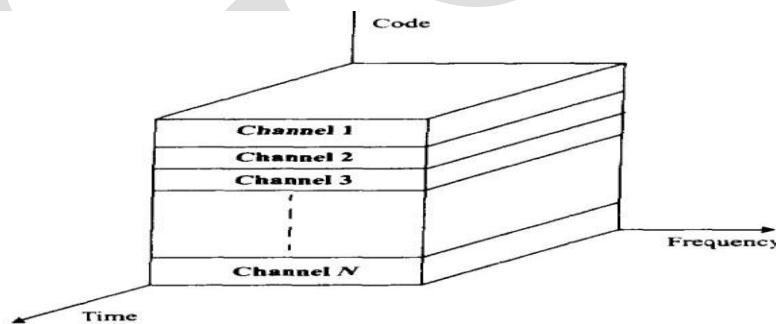

**Figure 4.5 CDMA in which each channel is assigned a unique PN code which is orthogonal to PN codes used by other users.**

The near-far problem occurs when many mobile users share the same channel. In general, the strongest received mobile signal will capture the demodulator at a base station. In CDMA, stronger received signal levels raise the noise floor at the base station demodulators for the weaker signals, thereby decreasing the probability that weaker signals will be received. To combat the near-far problem, **power control** is used in most CDMA implementations. Power control is provided by each base station in a cellular system and assures that each mobile within the base station coverage area provides the same signal level to the base station receiver. This solves the problem of a nearby subscriber overpowering the base station receiver and drowning out the signals of far away subscribers. Power control is implemented at the base station by rapidly sampling the **Radio Signal Strength Indicator** (RSSI) levels of each mobile and then sending a power change command over the forward radio link. Despite the use of power control within each cell, out-of-cell mobiles provide interference which is not under the control of the receiving base station. **The features of CDMA including the following:**

- Many users of a CDMA system share the same frequency. Either TDD or FDD may be used.
- Multipath fading may be substantially reduced because the signal is spread over a large spectrum. If the spread spectrum bandwidth is greater than the coherence bandwidth of the channel, the inherent frequency diversity will mitigate the effects of small-scale fading.
- Unlike TDMA or FDMA, CDMA has a soft capacity limit. Increasing the number of users in a CDMA system raises the noise floor in a linear manner. Thus, there is no absolute limit on the number of users in CDMA. Rather, the system performance gradually degrades for all users as the number of users is increased, and improves as the number of users is decreased.
- Channel data rates are very high in CDMA systems. Consequently, the symbol (chip) duration is very short and usually much less than the channel delay spread. Since PN sequences have low autocorrelation, multipath which is delayed by more than a chip will appear as noise. A RAKE receiver can be used to improve reception by collecting time delayed versions of the required signal.
- Since CDMA uses co-channel cells, it can use macroscopic spatial diversity to provide soft handoff. Soft handoff is performed by the MSC, which can simultaneously monitor a particular user from two or more base stations. The MSC may choose the best version of the signal at any time without switching frequencies.
- Self-jamming is a problem in CDMA system. Self-jamming arises from the fact that the spreading sequences of different users are not exactly orthogonal, hence in the despreading of a particular PN code, non-zero contributions to the receiver decision statistic for a desired

user arise from the transmissions of other users in the system.

- The near-far problem occurs at a CDMA receiver if an undesired user has a high detected power as compared to the desired user.

### Space Division Multiple Access (SDMA)

Space division multiple access (SDMA) controls the radiated energy for each user in space. It can be seen from Figure 8.8 that SDMA serves different users by using spot beam antennas. These different areas covered by the antenna beam may be served by the same frequency (in a TDMA or CDMA system) or different frequencies (in an FDMA system). **Sectorized** antennas may be thought of as a primitive application of SDMA. In the future, adaptive antennas will likely be used to simultaneously steer energy in the direction of many users at once and appear to be best suited for TDMA and CDMA base station architectures.

The reverse link presents the most difficulty in cellular systems for several reasons. First, the base station has complete control over the power of all the transmitted signals on the forward link.

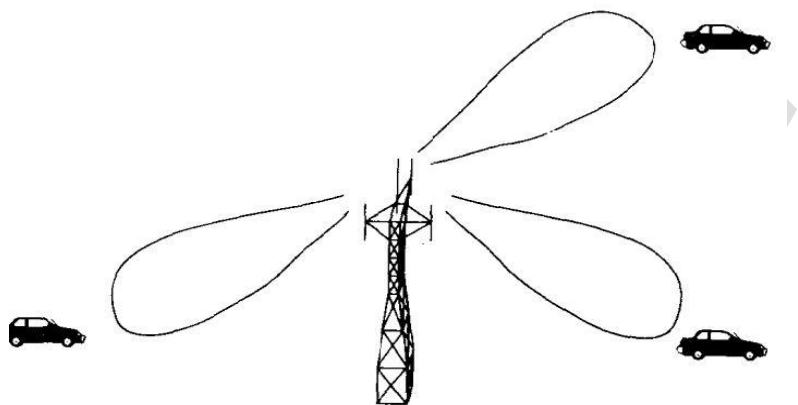

**Figure 8.8**

**A spatially filtered base station antenna serving different users by using spot beams.**

However, because of different radio propagation paths between each user and the base station, the transmitted power from each subscriber unit must be dynamically controlled to prevent any single user from driving up the interference level for all other users.

Second, transmit power is limited by battery consumption at the subscriber unit, therefore there are limits on the degree to which power may be controlled on the reverse link. If the base station antenna is made to spatially filter each desired user so that more energy is detected from each subscriber, then the reverse link for each user is improved and less power is required.

Adaptive antennas used at the base station (and eventually at the subscriber units) promise to mitigate some of the problems on the reverse link. In the limiting case of infinitesimal beamwidth and infinitely fast tracking ability, adaptive antennas implement optimal SDMA, thereby providing a unique channel that is free from the interference of all other users in the cell. With SDMA, all users within the system would be able to communicate at the same time using the same channel. In addition, a perfect adaptive antenna system would be able to track individual multipath components for each user and combine them in an optimal manner to collect all of the available signal energy from each user. The perfect adaptive antenna system is not feasible since it requires infinitely large antennas. However, section 8.7.2 illustrates what gains might be achieved using reasonably sized arrays with moderate directivities.

### **Packet Radio**

In packet radio (PR) access techniques, many subscribers attempt to access a single channel in an uncoordinated (or minimally coordinated) manner. Transmission is done by using bursts of data. Collisions from the simultaneous transmissions of multiple transmitters are detected at the base station receiver, in which case an ACK or NACK signal is broadcast by the base station to alert the desired user (and all other users) of received transmission. The ACK signal indicates an acknowledgment of a received burst from a particular user by the base station, and a NACK (negative acknowledgment) indicates that the previous burst was not received correctly by the base station. By using ACK and NACK signals, a PR system employs perfect feedback, even though traffic delay due to collisions may be high.

Packet radio multiple access is very easy to implement but has low spectral efficiency and may induce delays. The subscribers use a contention technique to transmit on a common channel. ALOHA protocols, developed for early satellite systems, are the best examples of contention techniques. ALOHA allows each subscriber to transmit

whenever they have data to send. The transmitting sub-scribers listen to the acknowledgment feedback to determine if transmission has been successful or not. If a collision occurs, the subscriber waits a random amount of time, and then retransmits the packet. The advantage of packet contention techniques is the ability to serve a large number of subscribers with virtually no overhead. The performance of contention techniques can be evaluated by the **throughput** (T), which is defined as the average number of messages successfully transmitted per unit time, and the average delay (D) experienced by a typical message burst.

## 1 Packet Radio Protocols

In order to determine the throughput, it is important to determine the vulnerable period,  $V_p$ , which is defined as the time interval during which the packets are susceptible to collisions with transmissions from other users. Figure 8.9 shows the vulnerable period for a packet using ALOHA [Tan81]. The Packet A will suffer a collision if other terminals transmit packets during the period  $t_1$  to  $t_1 + 2T$ . Even if only a small portion of packet A sustains a collision, the interference may render the message useless.

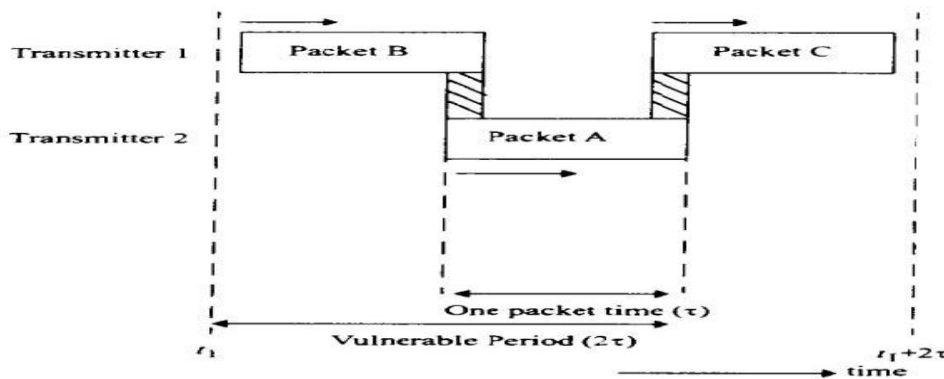

**Packet A will collide with packets B and C because of overlap in transmission time**

**Figure 4.9 Vulnerable period for a packet using the ALOHA protocol**

To study packet radio protocols, it is assumed that all packets sent by all users have a constant packet length and fixed, channel data rate, and all other users may generate new packets at random time intervals. Furthermore, it is assumed that packet transmissions occur with a Poisson distribution having a mean arrival rate of  $X$  packets per second. If  $T$  is the packet duration in seconds, then the traffic occupancy or throughput  $R$  of a packet radio network is given by

$$R = \lambda \tau \quad (8.6)$$

In equation (8.6),  $R$  is the normalized channel traffic due to arriving and buffered packets, and is a relative measure of the channel utilization. If  $R > 1$ , then the packets generated by the users exceed the maximum transmission rate of the channel [Tan81]. Thus, to obtain a reasonable throughput, the rate at which new packets are generated must



he within  $0 < R < 1$ . Under conditions of normal loading, the throughput  $T$  is the same as the total offered load,  $L$ . The load  $L$  is the sum of the newly generated packets and the retransmitted packets that suffered collisions in previous transmissions. The normalized throughput is always less than or equal to unity and may be thought of as the fraction of time (fraction of an Erlang) a channel is utilized. The normalized throughput is given as the total offered load times the probability of successful transmission, i.e.

$$T = R \Pr[\text{no collision}] = \lambda \tau \Pr[\text{no collision}]$$

where  $\Pr[\text{no collision}]$  is the probability of a user making a successful packet transmission. The probability that  $n$  packets are generated by the user population during a given packet duration interval is assumed to be Poisson distributed and is given as

$$\Pr(n) = \frac{R^n e^{-R}}{n!} \quad (8.8)$$

A packet is assumed successfully transmitted if there are no other packets transmitted during the given packet time interval. The probability that zero packets are generated (i.e., no collision) during this interval is given by

$$\Pr(0) = e^{-R} \quad (8.9)$$

Based on the type of access, contention protocols are categorized as random access, scheduled access, and hybrid access. In random access, there is no coordination among the users and the messages are transmitted from the users as they arrive at the transmitter. Scheduled access is based on a coordinated access of users on the channel, and the users transmit messages within allotted slots or time intervals. Hybrid access is a combination of random access and scheduled access.

### 1.1 Pure ALOHA

The pure ALOHA protocol is a random access protocol used for data transfer. A user accesses a channel as soon as a message is ready to be transmitted. After a transmission, the user waits for an acknowledgment on either the same channel or a separate feedback channel. In case of collisions, (i.e., when a NACK is received), the terminal waits for a random period of time and retransmits the message. As the number of users increase, a greater delay occurs because the probability of collision increases.

For the ALOHA protocol, the vulnerable period is double the packet duration (see Figure 8.9). Thus, the probability of no collision during the interval of  $2\tau$  is found by evaluating  $\Pr(n)$  given as

$$\Pr(n) = \frac{(2R)^n e^{-2R}}{n!} \quad (8.10)$$

One may evaluate the mean of equation (8.10) to determine the average number of packets sent during  $2\tau$  (This is useful in determining the average offered traffic). The probability of no collision is  $\Pr(0) = e^{-2R}$ . The throughput of the ALOHA protocol is found by using Equation (8.7) as

$$T = Re^{-2R} \quad (8.11)$$

### 1.2 Slotted ALOHA

In slotted ALOHA, time is divided into equal time slots of length greater than the packet duration ( $t_{ow}$ ). The subscribers each have synchronized clocks and transmit a message only at the beginning of a new time slot, thus resulting in a discrete distribution of packets. This prevents partial collisions, where one packet collides with a portion of another. As the number of users increase, a greater delay will occur due to complete collisions and the resulting repeated transmissions of those packets originally lost. The number of slots which a transmitter waits prior to retransmitting also determines the delay characteristics of the traffic. The vulnerable period for slotted ALOHA is only one packet duration, since partial collisions are prevented through synchronization. The probability that no other packets will be generated during the vulnerable period is  $e^{-R}$ . The throughput for the case of slotted ALOHA is thus given by

$$T = Re^{-R} \quad (8.12)$$

### 2 Carrier Sense Multiple Access (CSMA) Protocols

ALOHA protocols do not listen to the channel before transmission, and therefore do not exploit information about the other users. By listening to the channel before engaging in transmission, greater efficiencies may be achieved. CSMA protocols are based on the fact that each terminal on the network is able to monitor the status of the channel before transmitting information. If the channel is idle (i.e., no carrier is detected), then the user is allowed to transmit a packet based on a particular algorithm which is common to all transmitters on the network

In CSMA protocols, detection delay and propagation delay are two important parameters. Detection delay is a function of the receiver hardware and is the time required for a terminal to sense whether or not the channel is idle. Propagation delay is a relative measure of how fast it takes for a packet to travel from a base station to a mobile terminal. With a small detection time, a terminal detects a free channel quite rapidly, and small propagation delay means that a packet is transmitted through the channel in a small interval of time relative to the packet duration.

Propagation delay is important, since just after a user begins sending a packet, another user may be ready to send and may be sensing the channel at the same time. If the transmitting packet has not reached the user who is poised to send, the latter user will sense an idle channel and will also send its packet, resulting in a collision between the two packets. Propagation delay impacts the performance of CSMA protocols. If  $t_p$  is the propagation time in seconds,  $R_b$  is the channel bit rate, and  $m$  is the expected number of

bits in a data packet then the propagation delay can be expressed as

$$t_d = \frac{t_p R_b}{m} \quad (8.13)$$

**There exist several variations of the CSMA strategy :**

**1 -persistent CSMA –**

The terminal listens to the channel and waits for transmission until it finds the channel idle. As soon as the channel is idle, the terminal transmits its message with probability one.

**2. non-persistent CSMA –**

In this type of CSMA strategy, after receiving a negative acknowledgment the terminal waits a random time before retransmission of the packet. This is popular for wireless LAN applications, where the packet transmission interval is much greater than the propagation delay to the farthest user.

**3. p -persistent CSMA –**

p-persistent CSMA is applied to slotted channels. When a channel is found to be idle, the packet is transmitted in the first available slot with probability P or in the next slot with probability (1-P).

**4. CSMA/CD –**

In CSMA with collision detection (CD), a user monitors its transmission for collisions. If two or more terminals start a transmission at the same time, collision is detected, and the transmission is immediately aborted in midstream. This is handled by a user having both a transmitter and receiver which is able to support listen-while-talk operation. For a single radio channel, this is done by interrupting the transmission in order to sense the channel. For duplex systems, a full duplex transceiver is used.

**5. Data sense multiple access (DSMA) -** DSMA is a special type of CSMA that relies on successfully demodulating a forward control channel before broadcasting data back on a reverse channel. Each user attempts to detect a busy-idle message which is interspersed on the forward control channel. When the busy-idle message indicates that no users are transmitting on the reverse channel, a user is free to send a packet. This

technique is used in the cellular digital packet data (CDPD) cellular network.

## **Reservation Protocols:**

### **Reservation ALOHA**

Reservation ALOHA is a packet access scheme based on time division multiplexing. In this protocol, certain packet slots are assigned with priority, and it is possible for users to reserve slots for the transmission of packets. Slots can be permanently reserved or can be reserved on request. For high traffic conditions, reservations on request offers better throughput. In one type of reservation ALOHA, the terminal making a successful transmission reserves a slot permanently until its transmission is complete, although very large duration transmissions may be interrupted. Another scheme allows a user to transmit a request on a subslot which is reserved in each frame. If the transmission is successful (i.e, no collisions are detected), the terminal is allocated the next regular slot in the frame for data transmission .

#### **1. Packet Reservation Multiple Access (PRMA)**

PRMA uses a discrete packet time technique similar to reservation ALOHA and combines the cyclical frame structure of TDMA in a manner that allows each TDMA time slot to carry either voice or data, where voice is given priority. PRMA was proposed in as a means of integrating bursty data and human speech. PRMA defines a frame structure, much like is used in TDMA systems. Within each frame, there are a fixed number of time slots. which may be designated as either "reserved" or "available", depending on the traffic as determined by the controlling base station.

#### **2. Capture Effect in Packet Radio**

Packet radio multiple access techniques are based on contention within a channel. When used with FM or spread spectrum modulation, it is possible for the strongest user to successfully capture the intended receiver, even when many other users are also transmitting. Often, the closest transmitter is able to capture a receiver because of the small propagation path loss. This is called the **near-far effect**. The capture effect offers both advantages and disadvantages in practical systems. Because a particular transmitter may capture an intended receiver, many packets may survive despite collision on the channel. However, a strong transmitter may make it impossible for the receiver to detect a much weaker transmitter which is attempting to communicate to the same receiver. This problem is known as the **hidden transmitter** problem.

A useful parameter in analyzing the capture effects in packet radio protocols is the minimum power ratio of an arriving packet, relative to the other colliding packets, such that it is received. This ratio is called the **capture ratio**, and is dependent upon the receiver and the modulation

**Table 8.2 Multiple Access Techniques for Different Traffic Types**

Type of Traffic	Multiple Access Technique
Bursty, short messages	Contention protocols
Bursty, long messages, large number of users	Reservation Protocols
Bursty, long messages, small number of users	Reservation protocols with fixed TDMA reservation channel
Stream or deterministic (voice) used.	FDMA, TDMA, CDMA



## UNIT -5

### Wireless Networking

#### Introduction to Wireless Networks

The demand for ubiquitous personal communications is driving the development of new networking techniques that accommodate mobile voice and data users who move throughout buildings, cities, or countries. Consider the cellular telephone system shown in Figure 9.1. The cellular telephone system is responsible for providing coverage throughout a particular territory, called a coverage region or market. The interconnection of many such systems defines a wireless network capable of providing service to mobile users throughout a country or continent.

To provide wireless communications within a particular geographic region (a city, for example), an integrated network of base stations must be deployed to provide sufficient radio coverage to all mobile users. The base stations, in turn, must be connected to a central hub called the mobile switching center (MSC). The MSC provides connectivity between the public switched telephone network (PSTN) and the numerous base stations, and ultimately between all of the wireless subscribers in a system. The PSTN forms the global telecommunications grid which connects conventional (landline) telephone switching centers (called central offices) with MSCs throughout the world.

Figure 9.1 illustrates a **typical cellular system** of the early 1990s, but there is currently a major thrust to develop new transport architectures for the wireless end-users. For example, PCS may be distributed over the existing cable television plant to neighborhoods or city blocks, where microcells are used to provide local wireless coverage. Fiber optic transport architectures are also being used to connect radio ports, base stations, and MSCs.

To connect mobile subscribers to the base stations, radio links are established using a carefully defined communication protocol called common air interface (CAI) which in essence is a precisely defined handshake communication protocol. The common air interface specifies exactly how mobile subscribers and base stations communicate over radio frequencies and also defines the control channel signaling methods. The CAI must provide a great deal of channel reliability to ensure that data is properly sent and received between the mobile and the base station, and as such specifies speech and channel coding.

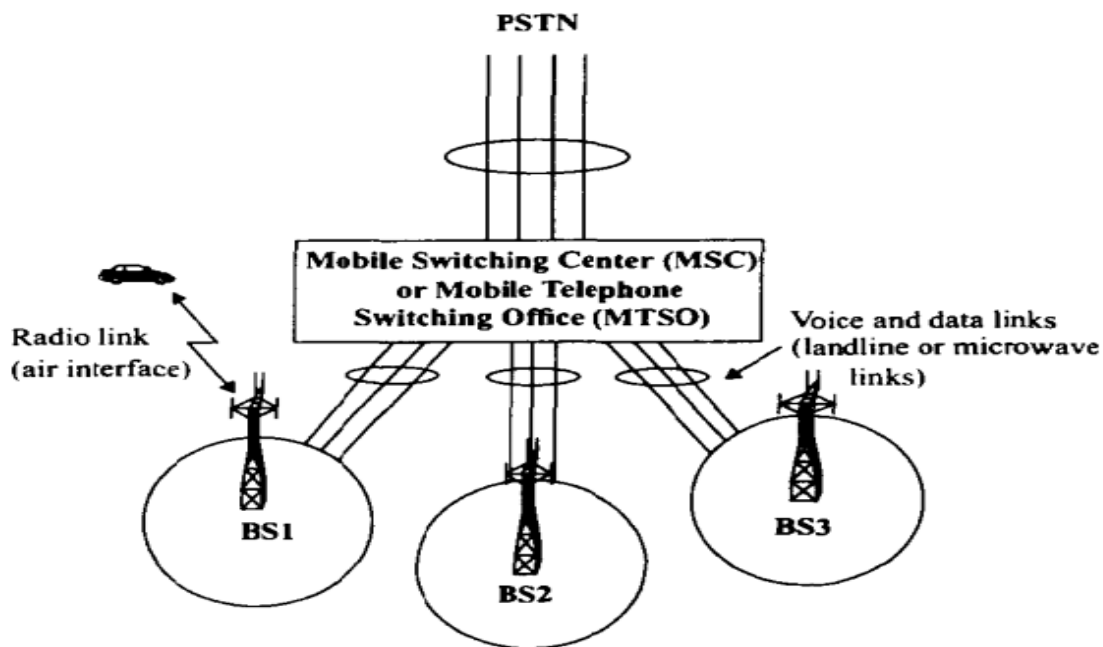

**Figure 9.1**

**Block diagram of a cellular system.**

At the base station, the air interface portion (i.e., signaling and synchronization data) of the mobile transmission is discarded, and the remaining voice traffic is passed along to the MSC on fixed networks. While each base station may handle on the order of 50 simultaneous calls, a typical MSC is responsible for connecting as many as 100 base stations to the PSTN (as many as 5,000 calls at one time), so the connection between the MSC and the PSTN requires substantial capacity at any instant of time. It becomes clear that networking strategies and standards may vary widely depending on whether a single voice circuit or an entire metropolitan population is served.

Unfortunately, the term network may be used to describe a wide range of voice or data connections, from the case of a single mobile user to the base station, to the connection of a large MSC to the PSTN. This broad network definition presents a challenge in describing the large number of strategies and standards used in networking, and it is not feasible to cover all aspects of wireless networking in this chapter. However, the basic concepts and standards used in today's wireless networks are covered in a manner which first addresses the mobile-to-base link, followed by the connection of the base station to the MSC, the connection of the MSC to the PSTN, and the interconnection of MSCs throughout the world

## **Differences Between Wireless and Fixed Telephone Networks**

Transfer of information in the public switched telephone network (PSTN) takes place over landline trunked lines (called trunks) comprised of fiber optic cables, copper cables, microwave links, and satellite links. The network configurations in the PSTN are virtually static, since the network connections may only be changed when a subscriber changes residence and requires reprogramming at the local central office (CO) of the subscriber. Wireless networks, on the other hand, are highly dynamic, with the network configuration being rearranged every time a subscriber moves into the coverage region of a different base station or a new market. While fixed networks are difficult to change, wireless networks must reconfigure themselves for users within small intervals of time (on the order of seconds) to provide roaming and imperceptible handoffs between calls as a mobile moves about. The available channel bandwidth for fixed networks can be increased by installing high capacity cables (fiber optic or coaxial cable), where as wireless networks are constrained by the meager RF cellular bandwidth provided for each user.

### **1 The Public Switched Telephone Network (PSTN)**

The PSTN is a highly integrated communications network that connects over 70% of the world's inhabitants. In early 1994, the International Telecommunications Union estimated that there were 650 million public landline telephone numbers, as compared to 30 million cellular telephone numbers [ITU93]. While landline telephones are being added at a 3% rate, wireless subscriptions are growing at greater than a 50% rate. Every telephone in the world is given calling access over the PSTN.

Each country is responsible for the regulation of the PSTN within its borders. Over time, some government telephone systems have become privatized by corporations which provide local and long distance service for profit.

In the PSTN, each city or a geographic grouping of towns is called a local access and transport area (LATA). Surrounding LATAs are connected by a company called a local exchange carrier (LEC). A LEC is a company that provides intra lata telephone service, and may be a local telephone company, or may be a telephone company that is regional in scope.

A long distance telephone company collects toll fees to provide connections between different LATAs over its long distance network. These companies are referred to as interexchange carriers (IXC), and own and operate large fiber optic and microwave radio networks which are connected to LECs throughout a country continent. In the United States, the 1984 divestiture decree (called the modified final judgement or MFJ) resulted in the break-up of AT&T (once the main local and long distance company in the U.S.) into seven major Bell Operating Companies (BOCs), each with its own service region. By U.S. Government mandate, AT&T is forbidden to provide local service within each BOC region (see Figure 9.2), although it is allowed to provide long distance service between LATAs within a BOC region and inter exchange service between each region.

BOCs are forbidden to provide interLATA calling within their own region and are also forbidden to provide the long distance interexchange service. In the U.S., there are about 2000 telephone companies, although the Bell Operating Companies (BOCs) are the most widely known (see Figure 9.2).





Figure 9.2  
Service areas of U.S. regional Bell Operating Companies.

Figure 9.3 is a simplified illustration of a local telephone network, called a local exchange. Each local exchange consists of a central office (CO) which provides PSTN connection to the customer premises equipment (CPE) which may be an individual phone at a residence or a private branch exchange (PBX) at a place of business. The CO may handle as many as a million telephone connections. The CO is connected to a tandem switch which in turn connects the local exchange to the PSTN. The tandem switch physically connects the local telephone network to the point of presence (POP) of trunked long distance lines provided by one or more IXC's [Pec921. Sometimes IXC's connect directly to the CO switch to avoid local transport charges levied by the LEC.

Figure 9.3 also shows how a PBX may be used to provide telephone connections throughout a building or campus. A PBX allows an organization or entity to provide internal calling and other in-building services (which do not involve the LEC), as well as private networking between other organizational sites (through leased lines from LEC and IXC providers), in addition to conventional local and long distance services which pass through the CO. Telephone connections within a PBX are maintained by the private owner, whereas connection of the PBX to the CO is provided and maintained by the LEC.

As compared with the local, fixed telephone network, where all end-users are static, a wireless communications system is extremely complex. First, the wireless network requires an air interface between base stations and subscribers to provide telephone grade communications under a wide range of propagation conditions and for any possible user location.

To assure adequate area coverage, the deployment of many (sometimes hundreds) of base stations throughout a market is necessary, and each of these base stations must be connected to the MSC. Furthermore, the MSC must eventually provide connection for each of the mobile users to the PSTN. This requires simultaneous connections to the LEC, one or more IXC's, and to other MSC's via a separate cellular signaling network.

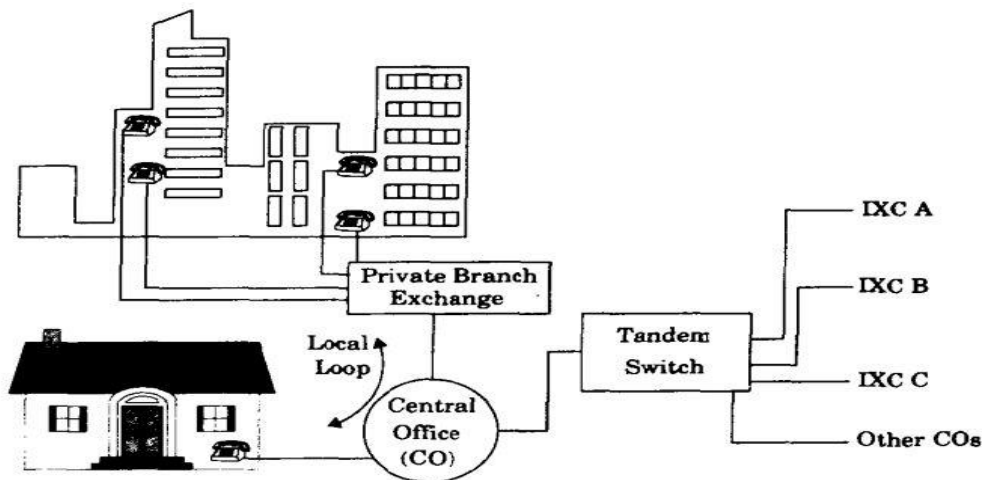

Figure 9.3  
Local landline telephone network.

Historically, the demand for wireless communications has consistently exceeded the capacity of available technology, and this is most evident in the design of MSCs. While a central office (CO) telephone switch may handle up to a million landline subscribers simultaneously, the most sophisticated MSCs of the mid 1990s are only able to handle 100,000 to 200,000 simultaneous cellular telephone subscribers.

A problem unique to wireless networks is the extremely hostile and random nature of the radio channel, and since users may request service from any physical location while traveling over a wide range of velocities, the MSC is forced to switch calls imperceptibly between base stations throughout the system. The radio spectrum available for this purpose is limited, thus wireless systems are constrained to operate in a fixed bandwidth to support an increasing number of users over time. Spectrally efficient modulation techniques, frequency reuse techniques, and geographically distributed radio access points are vital components of wireless networks. As wireless systems grow, the necessary addition of base stations increases the switching burden of the MSC. Because the geographical location of a mobile user changes constantly, extra overhead is needed by all aspects of a wireless network, particularly at the MSC, to ensure seamless communications, regardless of the location of the user.

## **Merging Wireless Networks and the PSTN**

Throughout the world, first generation wireless systems (analog cellular and cordless telephones) were deployed in the early and mid 1980's. As first generation wireless systems were being introduced, revolutionary advances were being made in the design of the PSTN by landline telephone companies. Until the mid 1980s, most analog landline telephone links throughout the world sent signaling information along the same trunked lines as voice traffic. That is, a single physical connection was used to handle both signaling traffic (dialed digits and telephone ringing commands) and voice traffic for each user. The overhead required in the PSTN to handle signaling data on the same trunks as voice traffic was inefficient, since this required a voice trunk to be dedicated during periods of time when no voice traffic was actually being carried. Put simply, valuable LEC and long distance voice trunks were being used to provide low, data rate signaling information that a parallel signaling channel could have provided with much less bandwidth.

The advantage of a separate but parallel signaling channel allows the voice trunks to be used strictly for revenue-generating voice traffic, and supports many more users on each trunked line. Thus, during the mid 1980s, the PSTN was transformed into two parallel networks -- one dedicated to user traffic, and one dedicated to call signaling traffic. This technique is called common channel signaling.

Common channel signaling is used in all modern telephone networks. Most recently, dedicated signaling channels have been used by cellular MSCs to provide global signaling interconnection, thereby enabling MSCs throughout the world to pass subscriber information. In many of today's cellular telephone systems, voice traffic is carried on the PSTN while signaling information for each call is carried on a separate signaling channel. Access to the signaling network is usually provided by IXC's for a negotiated fee. In North America, the cellular telephone signaling network uses No. 7 Signaling System (SS7), and each MSC uses the IS-41 protocol to communicate with other MSCs on the continent.

In first generation cellular systems, common signaling channels were not used, and signaling data was sent on the same trunked channel as the voice user. In second generation wireless systems, however, the air interfaces have been designed to provide parallel user and signaling channels for each mobile, so that each mobile receives the same features and services as fixed wireline telephones in the PSTN.

## Development of Wireless Networks

### 1 First Generation Wireless Networks

First generation cellular and cordless telephone networks are based on analog technology. All first generation cellular systems use FM modulation, and cordless telephones use a single base station to communicate with a single portable terminal. A typical example of a first generation cellular telephone system is the **Advanced Mobile Phone Services (AMPS)** system used in the United States. Basically, all first generation systems use the transport architecture shown in Figure

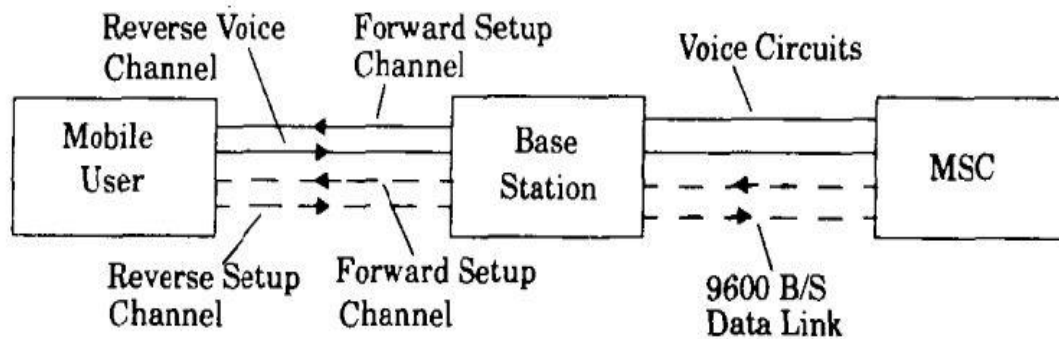

**Fig. Communication signaling between mobile, base station, and MSC in first generation wireless networks.**

Figure 9.5 shows a diagram of a first generation cellular radio network, which includes the mobile terminals, the base stations, and MSCs. In first generation cellular networks, the system control for each market resides in the MSC, which maintains all mobile related information and controls each mobile hand-off. The MSC also performs all of the network management functions, such as call handling and processing, billing, and fraud detection within the market.

The MSC is interconnected with the PSTN via landline trunked lines (trunks) and atadem switch. MSCs also are connected with other MSCs via dedicated signaling channels (see Figure 9.6) for exchange of location, validation, and call signaling information.

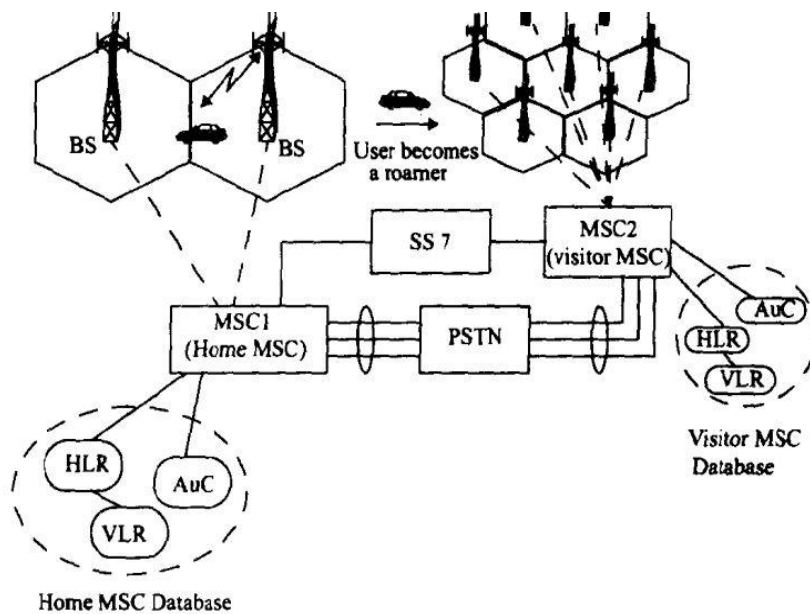

**HLR:** Home Location Register

**VLR:** Visitor Location Register

**AuC:** Authentication Center

**Figure 2.5** Block diagram of a cellular radio network.

Notice that in Figure 2.6, the PSTN is a separate network from the SS7 signaling network. In modern cellular telephone systems, long distance voice traffic is carried on the PSTN, but the signaling information used to provide call set-up and to inform MSCs about a particular user is carried on the SS7 network.

First generation wireless systems provide analog speech and inefficient, low-rate, data transmission between the base station and the mobile user. However, the speech signals are usually digitized using a standard, time division multiplex format for transmission between the base station and the MSC and are always digitized for distribution from the MSC to the PSTN. The global cellular network is required to keep track of all mobile users that are registered in all markets throughout the network, so that it is possible to forward incoming calls to roaming users at any location throughout the world. When a mobile user's phone is activated but is not involved in a call, it monitors the strongest control channel in the vicinity.

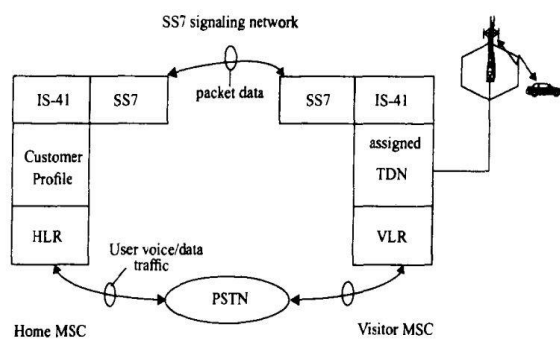

**Figure 9.6**

The North American Cellular Network architecture used to provide user traffic and signaling traffic between MSCs [From [NAC94] © IEEE]. The components of the SS7 network and their applications are described later in this chapter.

When the user roams into a new market covered by a different service provider, the wireless network must register the user in the new area and cancel its registration with the previous service provider so that calls may be routed to the roamer as it moves through the coverage areas of different MSCs.

Until the early 1990s, U.S. cellular customers that roamed between different cellular systems had to register manually each time they entered a new market during long distance travel. This required the user to call an operator to request registration. In the early 1990s, U.S. cellular carriers implemented the network protocol standard IS-41 to allow different cellular systems to automatically accommodate subscribers who roam into their coverage region. This is called **interoperator roaming**. IS-41 allows MSCs of different service providers to pass information about their subscribers to other MSCs on demand. IS-41 relies on a feature of AMPS called **autonomous registration**. Autonomous registration is a process by which a mobile notifies a serving MSC of its presence and location. The mobile accomplishes this by periodically keying up and transmitting its identity information, which allows the MSC to constantly update its customer list. The registration command is sent in the overhead message of each control channel at five or ten minute intervals, and includes a timer value which each mobile uses to determine the precise time at which it should respond to the serving base station with a registration transmission. Each mobile reports its MIN and ESN during the brief registration transmission so that the MSC can validate and update the customer list within the market.

The MSC is able to distinguish home users from roaming users based on the MIN of each active user, and maintains a real-time user list in the home location register (HLR) and visitor location register (VLR) as shown in Figure 9.5. IS-41 allows the MSCs of neighboring systems to automatically handle the registration and location validation of roamers so that users no longer need to manually register as they travel. The visited system creates a VLR record for each new roamer and notifies the home system via IS-41 so it can update its own HLR.

## AMPS Operation

- Subscriber initiates call by keying in phone number and presses send key
- MTSO verifies number and authorizes user
- MTSO issues message to user's cell phone indicating send and receive traffic channels
- MTSO sends ringing signal to called party
- Party answers; MTSO establishes circuit and initiates billing information
- Either party hangs up; MTSO releases circuit, frees channels, completes billing

## 2. Second Generation Wireless Networks

Second generation wireless systems employ digital modulation and advanced call processing capabilities. Examples of second generation wireless systems include the Global System for Mobile (GSM), the TDMA and CDMA U.S. digital standards (the Telecommunications Industry Association IS-54 and IS-95 standards), Second Generation Cordless Telephone (CT2), the British standard for cordless telephony, the Personal Access Communications System (PACS) local loop standard, and Digital European Cordless Telephone (DECT), which is the European standard for cordless and office telephony.

Second generation wireless networks have introduced new network architectures that have reduced the computational burden of the MSC. GSM has introduced the concept of a base station controller (BSC) which is inserted between several base stations and the MSC. In PACS/WACS, the BSC is called a radio port control unit. This architectural change has allowed the data interface between the base station controller and the MSC to be standardized, thereby allowing carriers to use different manufacturers for MSC and BSC components. This trend in standardization and interoperability is new to second generation wireless networks. Eventually, wireless network components, such as the MSC and BSC, will be available as off-the-shelf components, much like their wireline telephone counterparts.

All second generation systems use digital voice coding and digital modulation. The systems employ dedicated control channels (common channel signaling see section 9.7) within the air interface for simultaneously exchanging voice and control information between the subscriber, the base station, and the MSC while a call is in progress. Second generation systems also provide dedicated voice and signaling trunks between MSCs, and between each MSC and the PSTN.

In contrast to first generation systems, which were designed primarily for voice, second generation wireless networks have been specifically designed to provide paging, and other data services such as facsimile and high-data rate network access. The network controlling structure is more distributed in second generation wireless systems, since mobile stations assume greater control functions. In second generation wireless networks, the handoff process is mobile-controlled and is known as mobile assisted handoff.

The mobile units in these networks perform several other functions not performed by first generation subscriber units, such as received power reporting, adjacent base station scanning, data encoding, and encryption.

DECT is an example of a second generation cordless telephone standard which allows each cordless phone to communicate with any of a number of base stations, by automatically selecting the base station with the greatest signal level. In DECT, the base stations have greater control in terms of switching, signaling, and controlling handoffs. In general, second generation systems have been designed to reduce the computational and switching burden at the base station or MSC, while providing more flexibility in the channel allocation scheme so that systems may be deployed rapidly and in a less coordinated manner.



## Differences Between First and Second Generation Systems

- Digital traffic channels – first-generation systems are almost purely analog; second-generation systems are digital
- Encryption – all second generation systems provide encryption to prevent eavesdropping
- Error detection and correction – second-generation digital traffic allows for detection and correction, giving clear voice reception
- Channel access – second-generation systems allow channels to be dynamically shared by a number of users

### 3. Third Generation Wireless Networks

Third generation wireless systems will evolve from mature second generation systems. The aim of third generation wireless networks is to provide a single set of standards that can meet a wide range of wireless applications and provide universal access throughout the world. In third generation wireless systems, the distinctions between cordless telephones and cellular telephones will disappear, and a universal personal communicator (a personal handset) will provide access to a variety of voice, data, and video communication services.

Third generation systems will use the Broadband Integrated Services Digital Network (B-ISDN) to provide access to information networks, such as the Internet and other public and private databases. Third generation networks will carry many types of information (voice, data, and video), will operate in varied regions (dense or sparsely populated regions), and will serve both stationary users and vehicular users traveling at high speeds. Packet radio communications will likely be used to distribute network control while providing a reliable information transfer.

The terms Personal Communication System (PCS) and Personal Communication Network (PCN) are used to imply emerging third generation wireless systems for hand-held devices. Other names for PCS include Future Public Land Mobile Telecommunication Systems (FPLMTS) for worldwide use which has more recently been called International Mobile Telecommunication (IMT-2000), and Universal Mobile Telecommunication System (UMTS) for advanced mobile personal services in Europe.

### 4. Fixed Network Transmission Hierarchy

Wireless networks rely heavily on landline connections. For example, the MSC connects to the PSTN and SS7 networks using fiber optic or copper cable or microwave links. Base stations within a cellular system are connected to the MSC using line-of-sight(LOS) microwave links, or copper or fiber optic cables. These connections require high data rate serial transmission schemes in order to reduce the number of physical circuits between two points of connection. Several standard digital signaling (DS) formats form a transmission hierarchy that allows high data rate digital networks which carry a



large number of voice channels to be interconnected throughout the world. These DS formats use time division multiplexing (TDM). The most basic DS format in the U.S. is called

DS-0, which represents one duplex voice channel which is digitized into a 64kbps binary PCM format. The next DS format is DS-1, which represents twenty four full duplex DS-0 voice channels that are time division multiplexed into a 1.544 Mbps data stream (8 kbps is used for control purposes). Related to digital transmission hierarchy is the T(N) designation, which is used to denote trans-mission line compatibility for a particular DS format. DS-1 signaling is used for a T<sub>i</sub> trunk, which is a popular point-to-point network signaling format used to connect base stations to the MSC. T1 trunks digitize and distribute the twenty-four voice channels onto a simple four-wire full duplex circuit. In Europe, CEPT (Confe'rence Europe'ene Postes des et Te'le'communication) has defined a similar digital hierarchy.

Level 0 represents a duplex 64 kbps voice channel, whereas level 1 concentrates thirty channels into a 2.048 Mbps TDM data stream. Most of the world's PTI's have adopted the European hierarchy. Table 9.1 illustrates the digital hierarchy for North America and Europe

Typically, coaxial or fiber optic cable or wideband microwave links are used to transmit data rates in excess of 10 Mbps, whereas inexpensive wire (twisted pair) or coaxial cable may be used for slower data transfer. When connecting base stations to a MSC, or distributing trunked voice channels throughout a wireless network, T1 (DS1) or level 1 links are most commonly used and utilize common-twisted pair wiring. DS-3 and higher rate circuits are used to connect MSCs and COs to the PSTN.

## 5. Traffic Routing in Wireless Networks

The amount of traffic capacity required in a wireless network is highly dependent upon the type of traffic carried. For example, a subscriber's telephone call (voice traffic) requires dedicated network access to provide real-time communications, whereas control and signaling traffic may be bursty in nature and may be able to share network resources with other bursty users. Alternatively, some traffic may have an urgent delivery schedule while some may have no need to be sent in real-time. The type of traffic carried by a network determines the routing services, protocols, and call handling techniques which must be employed.

Two general routing services are provided by networks. These are **connection oriented** services (virtual circuit routing), and **connectionless services** (data-gram services). In connection-oriented routing, the communications path between the message source and destination is fixed for the entire duration of the message, and a call set-up procedure is required to dedicate network

**Table 9.1 Digital Transmission Hierarchy**

<b>Signal Level Rate</b>	<b>Digital Bit rate</b>	<b>Equivalent Voice Circuits</b>	<b>Carrier System</b>
<b>North America and Japan</b>			
DS-0	64.0 kbps	1	
DS-1	1.544 Mbps	24	T-1
DS-1C	3.152 Mbps	48	T-1C
DS-2	6.312 Mbps	96	T-2
DS-3	44.736 Mbps	672	T-3
DS-4	274.176 Mbps	4032	T-4
<b>CEPT (Europe and most other PTTs)</b>			
0	64.0 kbps	1	
1	2.048 Mbps	30	E-1
2	8.448 Mbps	120	E-1C
3	34.368 Mbps	480	E-2
4	139.264 Mbps	1920	E-3
5	565.148 Mbps	7680	E-4

resources to both the called and calling parties. Since the path through the network is fixed, the traffic in connection-oriented routing arrives at the receiver in the exact order it was transmitted. A connection-oriented service relies heavily on error control coding to provide data protection in case the network connection becomes noisy. If coding is not sufficient to protect the traffic, the call is broken, and the entire message must be retransmitted from the beginning.

Connectionless routing, on the other hand, does not establish a firm connection for the traffic, and instead relies on packet-based transmissions. Several packets form a message, and each individual packet in a connectionless service is routed separately. Successive packets within the same message might travel completely different routes and encounter widely varying delays throughout the network.

Packets sent using connectionless routing do not necessarily arrive in the order of transmission and must to be reordered at the receiver. Because packets take different routes in a connectionless service, some packets may be lost due to network or link failure, however others may get through with sufficient redundancy to enable the entire message to be recreated at the receiver. Thus, connectionless routing often avoids having to retransmit an entire message, but requires more overhead information for each packet. Typical packet overhead information includes the packet source address, the destination address, the

routing information, and information needed to properly order packets at the receiver. In a connectionless service, a call set-up procedure is not required at the beginning of a call, and each message burst is treated independently by the network.

## 1. Circuit Switching

First generation cellular systems provide connection-oriented services for each voice user. Voice channels are dedicated for users at a serving base station, and network resources are dedicated to the voice traffic upon initiation of a call. That is, the MSC dedicates a voice channel connection between the base station and the PSTN for the duration of a cellular telephone call. Furthermore, a call initiation sequence is required to connect the called and calling parties on a cellular system. When used in conjunction with radio channels, connection-oriented services are provided by a technique called **circuit switching**, since a physical radio channel is dedicated ("switched in to use") for two-way traffic between the mobile user and the MSC, and the PSTN dedicates a voice circuit between the MSC and the end-user. As calls are initiated and completed, different radio circuits and dedicated PSTN voice circuits are switched in and out to handle the traffic.

Circuit switching establishes a dedicated connection (a radio channel between the base and mobile, and a dedicated phone line between the MSC and the PSTN) for the entire duration of a call. Despite the fact that a mobile user may hand off to different base stations, there is always a dedicated radio channel to provide service to the user, and the MSC dedicates a fixed, full duplex phone connection to the PSTN.

Wireless data networks are not well supported by circuit switching, due to their short, bursty transmissions which are often followed by periods of inactivity. Often, the time required to establish a circuit exceeds the duration of the data transmission. Circuit switching is best suited for dedicated voice-only traffic, or for instances where data is continuously sent over long periods of time.

## 2. Packet Switching

Connectionless services exploit the fact that dedicated resources are not required for message transmission. Packet switching (also called virtual switching) is the most common technique used to implement connectionless services and allows a large number of data users to remain virtually connected to the same physical channel in the network. Since all users may access the network randomly and at will, call set-up procedures are not needed to dedicate specific circuits when a particular user needs to send data. Packet switching breaks each message into smaller units for transmission and recovery. When a message is broken into packets, a certain amount of control information is added to each packet to provide source and destination identification, as well as error recovery provisions.

*Figure 9.7 illustrates the sequential format of a packet transmission.* The packet consists of header information, the user data, and a trailer. The header specifies the beginning of a new packet and contains the source address, destination address, packet sequence number, and other routing and billing information. The user data contains information which is generally protected with error control coding. The trailer contains a cyclic redundancy checksum which is used for error detection at the receiver.

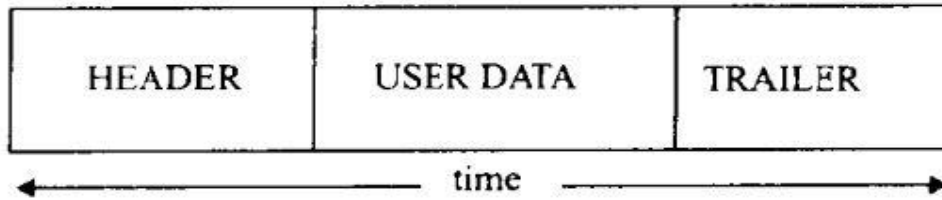

**Figure 9.7 Packet data format.**

Figure 9.8 shows the structure of a transmitted packet, which typically consists of five fields: the flag bits, the address field, the control field, the information field, and the frame check sequence field. The flag bits are specific (or reserved) bit sequences that indicate the beginning and end of each packet. The address field contains the source and the destination address for transmitting messages and for receiving acknowledgments. The control field defines functions such as transfer of acknowledgments, automatic repeat requests (ARQ), and packet sequencing. The information field contains the user data and may have variable length. The final field is the frame check sequence field or the CRC (Cyclic Redundancy Check) that is used for error detection.

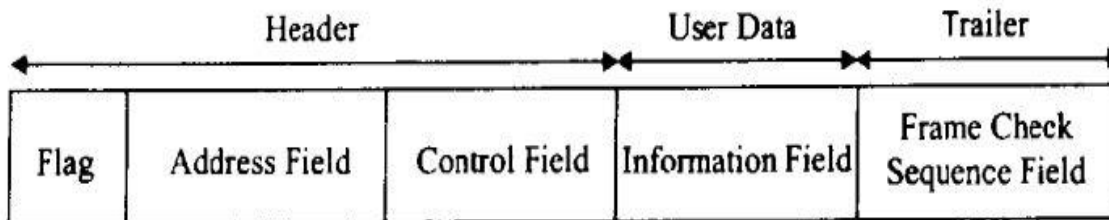

**Figure 9.8 Fields in a typical packet of data**

In contrast to circuit switching, packet switching (also called packet radio when used over a wireless link) provides excellent channel efficiency for bursty data transmissions of short length. An advantage of packet-switched data is that the channel is utilized only when sending or receiving bursts of information. This benefit is valuable for the case of mobile services where the available band-width is limited. The packet radio approach supports intelligent protocols for data flow control and retransmission, which can provide highly reliable transfer in degraded channel conditions. X.25 is a widely used packet radio protocol that defines a data interface for packet switching.

### Disadvantages of packet switching

#### Packet Switching Advantages

- Line efficiency is greater
  - Many packets over time can dynamically share the same node to node link
- Packet-switching networks can carry out data-rate conversion
  - Two stations with different data rates can exchange information
- Unlike circuit-switching networks that block calls when traffic is heavy, packet-switching still accepts packets, but with increased delivery delay
- Priorities can be used
- Each packet switching node introduces a delay
- Overall packet delay can vary substantially
  - This is referred to as jitter
  - Caused by differing packet sizes, routes taken and varying delay in the switches
- Each packet requires overhead information
  - Includes destination and sequencing information
  - Reduces communication capacity
- More processing required at each node

## The X.25 Protocol

X.25 was developed by CCITT (now ITU-T) to provide standard connectionless network access (packet switching) protocols for the three lowest layers (layers 1, 2, and 3) of the open systems interconnection (OSI) model (see Figure 9.14 for the OSI layer hierarchy). The X.25 protocols provide a standard network interface between originating and terminating subscriber equipment (called data terminal equipment or DTE), the base stations (called data circuit-terminating equipment or DCE), and the MSC (called the data switching exchange or DSE). The X.25 protocols are used in many packet radio air-interfaces, as well as in fixed networks. The X.25 protocol does not specify particular data rates or how packet-switched networks are implemented.

Figure 9.9 shows the hierarchy of X.25 protocols in the OSI model. The Layer 1 protocol deals with the electrical, mechanical, procedural, and functional interface between the subscriber (DTE), and the base station (DCE). The Layer 2 protocol defines the data link on the common air-interface between the subscriber and the base station. Layer 3 provides connection between the base station and the MSC, and is called the **packet layer protocol**. A packet assembler/disassembler (**PAD**) is used at Layer 3 to connect networks using the X.25 interface with devices that are not equipped with a standard X.25 interface.

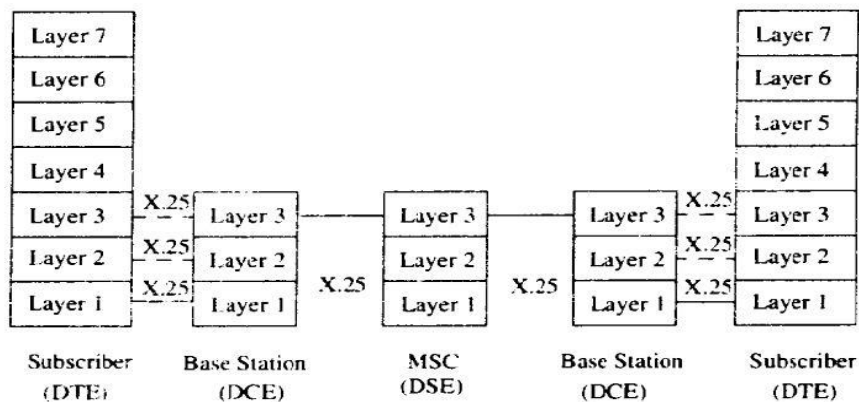

Figure 9.9 Hierarchy of X.25 in OSI model

## UNIT-6

### Wireless Data Services

- Circuit switching is inefficient for dedicated mobile data services such as facsimile (fax), electronic mail (e-mail), and short messaging.
- First generation cellular systems that provide data communications using circuit switching have difficulty passing modem signals through the audio filters of receivers designed for analog, FM, common air-interfaces.
- voice filtering must be deactivated when data is transmitted over first generation cellular networks, and a dedicated data link must be established over the common air-interface.
- The demand for packet data services has, until recently, been significantly less than the demand for voice services, and first generation subscriber equipment design has focused almost solely on voice-only cellular communications.
- However, in 1993, the U.S. cellular industry developed the cellular digital packet data (CDPD) standard to coexist with the conventional voice-only cellular system.
- In the 1980s, two other data-only mobile services called ARDIS and RMD were developed to provide packet radio connectivity through-out a network.

#### 1. Cellular Digital Packet Data (CDPD)

CDPD is a data service for first and second generation U.S. cellular systems and uses a full 30 kHz AMPS channel on a shared basis. CDPD provides mobile packet data connectivity to existing data networks and other cellular systems without any additional bandwidth requirements. It also capitalizes on the unused air time which occurs between successive radio channel assignments by the MSC (it is estimated that for 30% of the time, a particular cellular radio channel is unused, so packet data may be transmitted until that channel is selected by the MSC to provide a voice circuit).

CDPD directly overlays with existing cellular infrastructure and uses existing base station equipment, making it simple and inexpensive to install. Furthermore CDPD does not use the MSC, but rather has its own traffic routing capabilities. CDPD occupies voice channels purely on a secondary, non interfering basis, and packet channels are dynamically assigned (hopped) to different cellular voice channels as they become vacant, so the CDPD radio channel varies with time.

As with conventional, first generation AMPS, each CDPD channel is duplex in nature. The forward channel serves as a beacon and transmits data from the PSTN side of the network, while the reverse channel links all mobile users to the CDPD network and serves as the access channel for each subscriber. Collisions may result when many mobile users attempt to access the network simultaneously.

Each CDPD simplex link occupies a 30 kHz RF channel, and data is sent at 19,200 bps.

Since CDPD is packet-switched, a large number of modems are able to access the same channel on an as needed, packet-by-packet basis. CDPD supports broadcast, dispatch, electronic mail, and field monitoring applications. GMSK BT=0.5 modulation is used so that existing analog FM cellular receivers can easily detect the CDPD format without redesign.

CDPD transmissions are carried out using fixed-length blocks. User data is protected using a Reed Solomon (63,47) block code with 6-bit symbols. For each packet, 282 user bits are coded into 378 bit blocks, which provide correction for up to eight symbols.

Two lower layer protocols are used in CDPD. The **mobile data link protocol (MDLP)** is used to convey information between data link layer entities (layer 2 devices) across the CDPD air interface. The MDLP provides logical data link connections on a radio channel by using an address contained in each packet frame. The MDLP also provides sequence control to maintain the sequential order of frames across a data link connection, as well as error detection and flow control.

The **Radio Resource Management Protocol (RRMP)** is a higher, layer 3 protocol used to manage the radio channel resources of the CDPD system and enables an M-ES to find and utilize a duplex radio channel without interfering with standard voice services. The RRMP handles base-station identification and configuration messages for all M-ES stations, and provides information that the M-ES can use to determine usable CDPD channels without knowledge of the history of channel usage. The RRMP also handles channel hopping commands, cell hand-offs, and M-ES change of power commands. CDPD version 1.0 uses the X.25 **wide area network (WAN)** subprofile and frame relay capabilities for internal subnetworks.

Table 9.2 lists the link layer characteristics for CDPD. Figure 9.10 illustrates a typical CDPD network. Note that the subscribers (the mobile end system, or M-ES) are able to connect through the **mobile data base stations (MDBS)** to the Internet via **intermediate systems (MD-IS)**, which act as servers and routers for the subscribers. In this way, mobile users are able to connect to the Internet or the PSTN. Through the I-interface, CDPD can carry either Internet protocol (IP) or OSI connectionless protocol (CLNP) traffic.

**Table 9.2 Link Layer Characteristics for CDPD**

Protocols	MDLP, RRMP, X.25
Channel Data Rate (bps)	19,200
Channel Bandwidth (kHz)	30
Spectrum Efficiency (b/Hz)	0.64
Random Error Strategy	cover with burst protect
Burst Error Strategy	RS 63,47 (6 bits per symbol)
Fading Performance	withstands 2.2 ms fade
Channel Access	slotted DSMA/CD

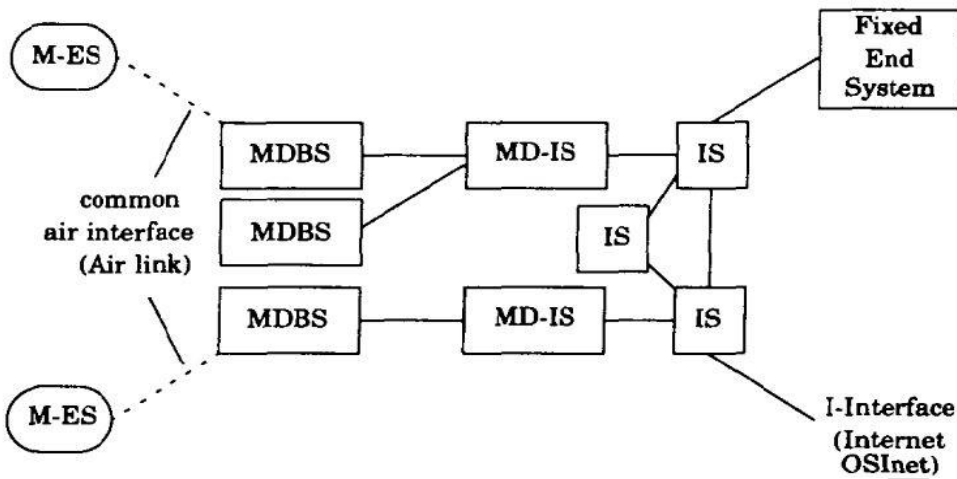

**M-ES** :Mobile End Station  
**MDBS** Mobile Data Base Station  
**MD-IS** Intermediate Server for CDPD traffic

*Figure 9.10 The CDPD network.*

## 2 Advanced Radio Data Information Systems (ARDIS)

Advance Radio Data Information Systems (ARDIS) is a private network service provided by Motorola and IBM and is based on MDC 4800 and RD-LAP (Radio Data Link Access Procedure) protocols developed at Motorola [DeR94]. ARDIS provides 800 MHz two-way mobile data communications for short-length radio messages in urban and in-building environments, and for users traveling at low speeds. Short ARDIS messages have low retry rates but high packet over-head, while long messages spread the overhead over the length of the packet but have a higher retry rate. ARDIS has been deployed to provide excellent in-building penetration, and large-scale spatial antenna diversity is used to receive messages from mobile users. When a mobile sends a packet, many base stations which are tuned to the transmission frequency attempt to detect and decode the transmission, in order to provide diversity reception for the case when multiple mobiles contend for the reverse link. In this manner, ARDIS base stations are able to insure detection of simultaneous transmissions, as long as the users are sufficiently separated in space. Table 9.3 lists some characteristics for ARDIS.

## 3. RAM Mobile Data (RMD)

RAM Mobile Data (RMD) is a public, two-way data service based upon the Mobitex protocol developed by Ericsson. RAM provides street level coverage for short and long messages for users moving in an urban environment. RAM has capability for voice and data transmission, but has been designed primarily for data and facsimile. Fax messages are transmitted as normal text to a gateway processor, which then converts the radio message to an appropriate format by merging it with a background page. Thus, the packet-switched wireless transmission consists of a normal length message instead of a much larger fax image, even though the end-user receives what appears to be a standard fax [DeR94]. some characteristics of the RAM mobile data service.



### Channel Characteristics for ARDIS

Protocol	MDC 4800	RD-LAP
Speed (bps)	4800	19,200
Channel Bandwidth (kHz)	25	25
Spectrum Efficiency (b/Hz)	0.19	0.77
Random Error Strategy	convolutional 1/2, k=7	trellis coded modulation, rate = 3/4
Burst Error Strategy	interleave 16 bits	interleave 32 bits
Fading Performance	withstands 3.3 ms fade	withstands 1.7ms fade
Channel Access	CSMA nonpersistent	slot CSMA

### Channel Characteristics for RAM Mobile Data

Protocol	Mobitex
Speed (bps)	8000
Channel Bandwidth (kHz)	12.5
Spectrum Efficiency (b/Hz)	0.64
Random Error Strategy	12, 8 Hamming code
Burst Error Strategy	interleave 21 bits
Fading Performance	withstands 2.6 ms fade
Channel Access	slotted CSMA

## 4. Common Channel Signaling (CCS)

Common channel signaling (CCS) is a digital communications technique that provides simultaneous transmission of user data, signaling data, and other related traffic throughout a network. This is accomplished by using out-of-band signaling channels which logically separate the network data from the user information (voice or data) on the same channel. For second generation wireless communications systems, CCS is used to pass user data and control/supervisory signals between the subscriber and the base station, between the base station and the MSC, and between MSCs. Even though the concept of CCS implies dedicated, parallel channels, it is implemented in a TDM format for serial data transmissions.

Before the introduction of CCS in the 1980s, signaling traffic between the MSC and a subscriber was carried in the same band as the end-user's audio. The network control data passed between MSCs in the PSTN was also carried inband, requiring that network information be carried within the same channel as the subscriber's voice traffic throughout the PSTN. This technique, called inband signaling, reduced the capacity of the PSTN, since the network signaling data rates were greatly constrained by the limitations of the carried voice channels, and the PSTN was forced to sequentially (not simultaneously) handle signaling and user data for each call.

CCS is an out-of-band signaling technique which allows much faster communications between two nodes within the PSTN. Instead of being constrained to signaling data rates which are on the order of audio frequencies, CCS supports signaling data rates from 56 kbps to many megabits per second. Thus, network signaling data is carried in a seemingly parallel, out-of-band, signaling channel while only user data is carried on the PSTN. CCS provides a substantial increase in the number of users which are served by trunked PSTN lines, but requires that a dedicated portion of the trunk time be used to provide a signaling channel used for network traffic. In first generation cellular systems, the SS7 family of protocols, as defined by

the Integrated System Digital Network (ISDN) are used to provide CCS.

Since network signaling traffic is bursty and of short duration, the signaling channel may be operated in a connectionless fashion where packet data transfer techniques are efficiently used. CCS generally uses variable length packet sizes and a layered protocol structure. The expense of a parallel signaling channel is minor compared to the capacity improvement offered by CCS through-out the PSTN, and often the same physical network connection (i.e., a fiber optic cable) carries both the user traffic and the network signaling data.

#### 4.1. The Distributed Central Switching Office for CCS

As more users subscribe to wireless services, backbone networks that link MSCs together will rely more heavily on network signaling to preserve message integrity, to provide end-to-end connectivity for each mobile user, and to maintain a robust network that can recover from failures. CCS forms the foundation of network control and management functions in second and third generation networks. Out-of-band signaling networks which connect MSCs throughout the world enable the entire wireless network to update and keep track of specific mobile users, wherever they happen to be. Figure 9.6 illustrates how an MSC is connected to both the PSTN and the signaling network.

As shown in Figure 9.11, the CCS network architecture is composed of geographically distributed central switching offices, each with embedded switching end points (SEPs), signaling transfer points (STPs), a service management system (SMS), and a database service management system (DBAS)

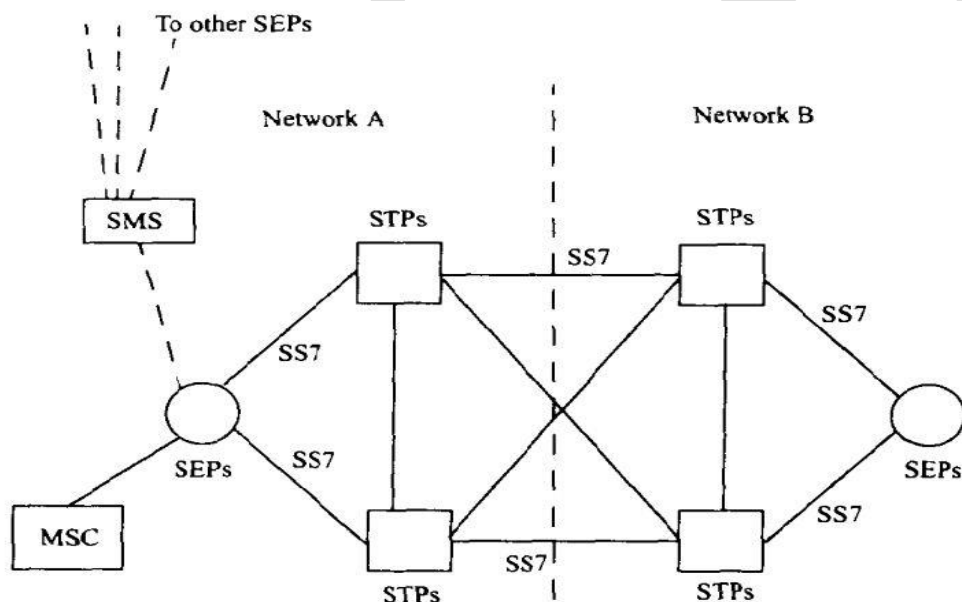

SEPs: Switching End Points

STPs: Signaling Transfer Points

SMS: Service Management System

SS7: Signaling System No. 7

**Figure 9.11**

**Common channel signaling (CCS) network architecture showing STPs, SEPs, and SMS embedded within a central switching office, based on SS7.**

The MSC provides subscriber access to the PSTN via the SEP. The SEP implements a stored-program-control switching system known as the **service control point (SCP)** that uses CCS to set up calls and to access a network database. The SCP instructs the SEP to create billing records based on the call information recorded by the SCP.

The **STP** controls the switching of messages between nodes in the CCS network. For higher reliability of transmission (redundancy), SEPs are required to be connected to the SS7 network (described in Section 9.8) via at least two STPs. This combination of two STPs in parallel is known as a **mated pair**, and provides connectivity to the network in the event one STP fails.

The SMS contains all subscriber records, and also houses toll-free databases which may be accessed by the subscribers. The **DBAS** is the administrative database that maintains service records and investigates fraud throughout the network. The SMS and DBAS work in tandem to provide a wide range of customer and network provider services, based on SS7.

## 5 .Integrated Services Digital Network (ISDN)

Integrated Services Digital Network (ISDN) is a complete network framework designed around the concept of common channel signaling. While telephone users throughout the world rely on the PSTN to carry conventional voice traffic, new end-user data and signaling services can be provided with a parallel, dedicated signaling network. ISDN defines the dedicated signaling network that has been created to complement the PSTN for more flexible and efficient network access and signaling and may be thought of as a parallel world-wide network for signaling traffic that can be used to either route voice traffic on the PSTN or to provide new data services between network nodes and the end-users.

ISDN provides two distinct kinds of signaling components to end-users in a telecommunications network. The first component supports traffic between the end-user and the network, and is called **Access signaling**. Access signaling defines how end-users obtain access to the PSTN and the ISDN for communications or services, and is governed by a suite of protocols known as the **Digital Subscriber Signaling System number 1(DSS1)**. The second signaling component of ISDN is network signaling, and is governed by the SS7 suite of protocols. For wireless communications systems, the SS7 protocols within ISDN are critical to providing backbone network connectivity between MSCs through-out the world, as they provide network interfaces for common channel signaling traffic.

ISDN provides a complete digital interface between end-users over twisted pair telephone lines. The ISDN interface is divided into three different types of channels. Information bearing channels called **bearer channels** (B channels) are used exclusively for end-user traffic (voice, data, video). Out-of-band signaling channels, called **data channels** (D channels), are used to send signaling and control information across the interface to end-users. As shown in Figure 9.12, ISDN provides integrated end-user access to both circuit-switched and packet switched networks with digital end-to-end connectivity.

ISDN end-users may select between two different interfaces, the **Basic rate interface** (BRI) or the primary rate interface (PRI). The BRI is intended to serve small capacity terminals (such as single line telephones) while the PRI is intended for large capacity terminals (such as PBXs). The B channels support 64 kbps data for both the primary rate and the basic rate interfaces. The D channel supports 64 kbps for the primary rate and 16 kbps for the basic

rate. The BRI provides two 64 kbps bearer channels and one 16 kbps signaling channel (2B+D), whereas the PRI provides twenty-three 64 kbps bearer channels and one 64 kbps signaling channel (23B+D) for North America and Japan. In Europe, the primary rate interface provides thirty basic information channels and one 64 kbps signaling channel (30B+D). The PRI service is designed to be carried by DS-1 or CEPT level 1 links .

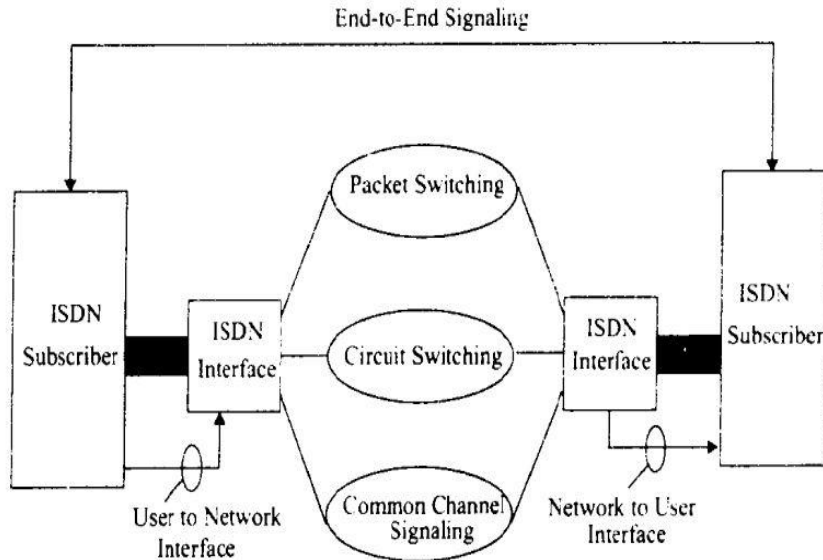

**Figure 9.12 Block diagram of an Integrated Services Digital Network**

Even though the diagram illustrates parallel channels, the TDM-based serial data structure uses a single twisted pair.

For wireless service subscribers, an ISDN basic rate interface is provided in exactly the same manner as for a fixed terminal. To differentiate between wireless and fixed subscribers, the mobile BRI defines signaling data (D channels in the fixed network) as control channels (C channels in the mobile network), so that a wireless subscriber has 2B+C service.

Much like the digital signaling hierarchy described in Section 9.2, several ISDN circuits may be concatenated into high speed information channels (H channels). H channels are used by the ISDN backbone to provide efficient data transport of many users on a single physical connection, and may also be used by PRI end-users to allocate higher transmission rates on demand. ISDN defines HO channels (384 kbps), H11 (1536 kbps), and H12 channels (1920 kbps) as shown in Table 9.5

**Table 9.5 Types of Bearer Services in ISDN**

Mode of Service	Type of Service	Speed of Transmission	Type of Channel
Circuit mode services	unrestricted	64 kbps, 384 kbps, 1.5 Mbps	B, H0, H11
Circuit mode service	speech	64 kbps	B
Packet radio services	unrestricted	depending on throughput	B, D (or C)

### 5.1. Broadband ISDN and ATM

With the proliferation of computer systems and video imaging, end-user applications are requiring much greater bandwidths than the standard 64 kbps B channel provided by ISDN. Recent work has defined ISDN interface standards that increase the end user transmission bandwidth to several Mb's. This emerging networking technique is known as broadband ISDN (B-ISDN) and is based on asynchronous transfer mode (ATM) technology which allows packet switching rates up to **2.4 Gbps** and total switching capacities as high as **100 Gbps**.

ATM is a packet switching and multiplexing technique which has been specifically designed to handle both voice users and packet data users in a single physical channel. ATM data rates vary from low traffic rates (64 kbps) over twisted pair to over 100 Mbps over fiber optic cables for high traffic rates between network nodes. ATM supports bidirectional transfer of data packets of fixed length between two end points, while preserving the order of transmission. ATM data units, called cells, are routed based on header information in each unit (called a label) that identifies the cell as belonging to a specific ATM virtual connection.

The label is determined upon virtual connection of a user, and remains the same throughout the transmission for a particular connection. The ATM header also includes data for congestion control, priority information for queuing of packets, and a priority which indicates which ATM packets can be dropped in case of congestion in the network,

Figure 9.13 shows the cell format of ATM. ATM cells (packets) have a fixed length of 53 bytes, consisting of 48 bytes of data and 5 bytes of header information. Fixed length packets result in simple implementation of fast packet switches, since packets arrive synchronously at the switch. A compromise was made in selecting the length of ATM cells to accommodate both voice and data users.

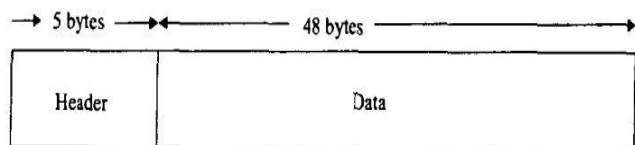
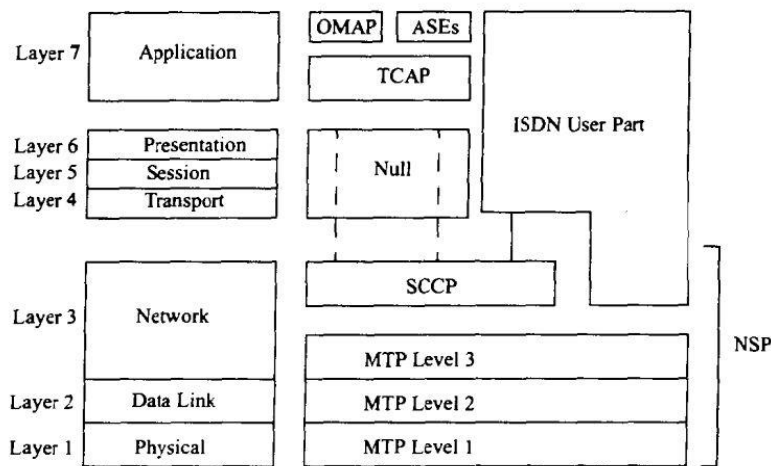

**Figure 9.13 Cell format of Asynchronous Transfer Mode (ATM).**

### 6. Signaling System No. 7 (SS7)

The SS7 signaling protocol is widely used for common channel signaling between interconnected networks (see Figure 9.11, for example). SS7 is used to interconnect most of the cellular MSCs throughout the U.S., and is the key factor in enabling autonomous registration and automated roaming in first generation cellular systems.

SS7 is an outgrowth of the out-of band signaling first developed by the CCITT under common channel signaling standard, CCS No. 6. Further work caused SS7 to evolve along the lines of the ISO-OSI seven layer network definition, where a highly layered structure (transparent from layer to layer) is used to provide network communications. Peer layers in the ISO model communicate with each other through a virtual (packet data) interface, and a hierarchical interface structure is established. A comparison of the OSI-7 network model and the SS7 protocol standard is given in Figure 9.14. The lowest three layers of the OSI model are handled in SS7 by the network service part (NSP) of the protocol, which in turn is made up of three message transfer parts (MTPs) and the signaling connection control part (SCCP) of the SS7 protocol.



OMAP: Operations Maintenance and Administration Part ASE: Application Service Element  
 TCAP : Transaction Capabilities Application Part SCCP: Signaling Connection Control Part  
 MTP : Message Transfer Part  
 NSP : Network Service Part

**Figure 9.14 SS7 protocol architecture**

## 6.1 Network Services Part (NSP) of SS7

The NSP provides ISDN nodes with a highly reliable and efficient means of exchanging signaling traffic using connectionless services. The SCCP in SS7 actually supports packet data network interconnections as well as connection oriented networking to virtual circuit networks. The NSP allows network nodes to communicate throughout the world without concern for the application or context of the signaling traffic.

### 6.1.1 Message Transfer Part (MTP) of SS7

The function of the MTP is to ensure that signaling traffic can be transferred and delivered reliably between the end-users and the network. MTP is provided at three levels. Figure 9.15 shows the functionality of the various MTP levels that will be described.

Signaling data link functions (MTP Level 1) provide an interface to the actual physical channel over which communication takes place. Physical channels may include copper wire, twisted pair, fiber, mobile radio, or satellite links, and are transparent to the higher

layers. CCITT recommends that MTP Level 1 use 64 kbps transmissions, whereas ANSI recommends 56 kbps. The minimum data rate provided for telephony control operations is 4.8 kbps .

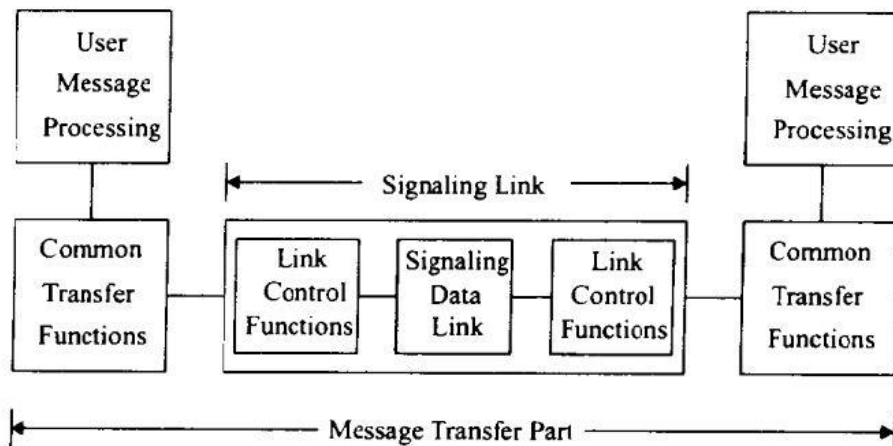

**Figure 9.15 Functional diagram of message transfer part**

**Signaling link functions (MTP Level 2)** correspond to the second layer in the OSI reference model and provide a reliable link for the transfer of traffic between two directly connected signaling points. Variable length packet messages, called message signal units (MSUs), are defined in MTP Level 2. A single MSU cannot have a packet length which exceeds 272 octets, and a standard: 16 bit cyclic redundancy check (CRC) checksum is included in each MSU for error detection. A wide range of error detection and correction features are provided in MTP Level 2.

MTP Level 2 also provides flow control data between two signaling points as a means of sensing link failure. If the receiving device does not respond to data transmissions, MTP Level 2 uses a timer to detect link failure, and notifies the higher levels of the SS7 protocol which take appropriate actions to reconnect the link.

Signaling network functions (MTP Level 3) provide procedures that transfer messages between signaling nodes. As in ISDN, there are two types of MTP Level 3 functions: signaling message handling and signaling network management. Signaling message handling is used to provide routing, distribution, and traffic discrimination (discrimination is the process by which a signaling point determines whether or not a packet data message is intended for its use or not). Signaling network management allows the network to reconfigure in case of node failures, and has provisions to allocate alternate routing facilities in the case of congestion or blockage in parts of the network.

### **6.1.2 Signaling Connection Control Part (SCCP) of SS7**

The signaling connection control part (SCCP) provides enhancement to the addressing capabilities provided by the MTP. While the addressing capabilities of MTP are limited in

nature, SCCP uses local addressing based on subsystem numbers (SSNs) to identify users at a signaling node. SCCP also provides the ability to address global title messages, such as 800 numbers or non billed numbers. SCCP provides four classes of service: two are connectionless and two are connection-oriented, as shown in Table 9.6.

**Table 9.6 Different Classes of Service Provided by SCCP**

<b>Class of Service</b>	<b>Type of Service</b>
Class 0	Basic connection class
Class 1	Sequenced (MTP) connectionless class
Class 2	Basic connection-oriented class
Class 3	Flow control connection-oriented class

SCCP consists of four functional blocks. The SCCP connection-oriented control block provides data transfer on signaling connections. The SCCP management block provides functions to handle congestion and failure conditions that cannot be handled at the MTP. The SCCP routing block routes forwards messages received from MTP or other functional blocks.

## **7. The SS7 User Part**

As shown in Figure 9.14, the SS7 user part provides call control and management functions and call set-up capabilities to the network. These are the higher layers in the SS7 reference model, and utilize the transport facilities provided by the MTP and the SCCP. The SS7 user part includes the ISDN user part (ISUP), the transaction capabilities application part (TCAP) and the operations maintenance and administration part (OMAP). The telephone User part (TUP) and the data user part (DUP) are included in the ISUP.

### **7.1. Integrated Services Digital Network User Part (ISUP)**

The ISUP provides the signaling functions for carrier and supplementary services for voice, data, and video in an ISDN environment. In the past, telephony requirements were lumped in the TUP, but this is now a subset of ISUP. ISUP uses the MTP for transfer of messages between different exchanges. ISUP message includes a routing label that indicates the source and destination of the message, a circuit identification code (CIC), and a message code that serves to define the format and function of each message. They have variable lengths with a maximum of 272 octets that include MTP level headers. In addition to the basic bearer services in an ISDN environment, the facilities of user-to-user signaling, closed user groups, calling line identification, and call forwarding are provided.

### **7.2. Transaction Capabilities Application Part (TCAP)**

The transaction capabilities application part in SS7 refers to the application layer which invokes the services of the SCCP and the MTP in a hierarchical format. One application at a node is thus able to execute an application at another node and use these results. Thus,



TCAP is concerned with remote operations. TCAP messages are used by IS-41.

### 7. 3. Operation Maintenance and Administration Part (OMAP)

The OMAP functions include monitoring, coordination, and control functions to ensure that trouble free communications are possible. OMAP supports diagnostics are known throughout the global network to determine loading and specific sub network behaviors.

### 8. Signaling Traffic in SS7

Call set-ups, inter-MSC handoffs, and location updates are the main activities that generate the maximum signaling traffic in a network, and which are all handled under SS7. Setting up of a call requires exchange of information about the location of the calling subscriber (call origination, calling-party procedures) and information about the location of the called subscriber. Either or both, of the calling and the called subscribers can be mobile, and whenever any of the mobile subscribers switches MSCs under a handoff condition, it adds to the amount of information exchanged. Table 9.7 shows the amount of signaling traffic that is generated for call set-up in GSM [Mei93). Location update records are updated in the network whenever a subscriber moves to a new location. The traffic required by the location update process as a subscriber moves within and between VLR areas is shown in Table 9.8.

**Table 9.8 Signaling Load for Location Updating in GSM**

<b>Location Updating</b>	<b>Load</b>
Information on the current MSC and associated VLR	406 bytes
Information on the current VLR and HLR	55 bytes
Information on new VLR and old VLR	406 bytes
Information on the new VLR and old VLR	213 bytes
Information on the old VLR and HLR	95 bytes
Information on the new VLR and HLR	182 bytes

**Table 9.7 Signaling Load for Call Setup and Handoffs in GSM**

<b>Call originating from a Mobile</b>	<b>Load</b>
Information on the originating MSC and the terminating switch	120 bytes
Information on the originating MSC and the associated VLR	550 bytes
<b>Call terminating at a Mobile</b>	
Information on the switch and terminating MSC	120 bytes
Information on the terminating MSC and associated VLR	612 bytes
Information on the originating switch and HLR	126 bytes
<b>InterMSC handoffs</b>	
Information on the new MSC and associated VLR	148 bytes
Information on the new MSC and old MSC	383 bytes

## SS7 Services

There are three main type of services offered by the SS7 network the Touchstar, 800 services, and alternate billing services. These services are briefly explained below.

**Touchstar** - This kind of service is also known as CLASS and is a group of switch-controlled services that provide its users with certain call management capabilities. Services such as call return, call forwarding, repeat dialing, call block, call tracing, and caller ID are provided.

**800 services** - These services were introduced by Bell System to provide toll-free access to the calling party to the services and database which is offered by the private parties. The costs associated with the processing of calls is paid by the service subscriber. The service is offered under two plans known as the 800-NXX plan, and the 800 Database plan. In the 800-NXX plan the first six digits of an 800 call are used to select the interexchange carrier (IXC). In the 800 Database plan, the call is looked up in a database to determine the appropriate carrier and routing information.

**Alternate Billing Service and Line Information Database (ADB/LIDB)** - These services use the CCS network to enable the calling party to bill a call to a personal number (third party number, calling card, or collect etc.) from any number.

## Performance of SS7

The performance of the signaling network is studied by connection set-up time (response time) or the end-to-end signaling information transfer time. The delays in the signaling point (SP) and the STP depend on the specific hardware configuration and switching software implementation. The maximum limits for these delay times have been specified in the CCITT recommendations.

**Congestion Control in SS7 networks** - With an increasing number of subscribers, it becomes important to avoid congestion in the signaling network under heavy traffic conditions [Mod92], [Man93]. SS7 networking protocols provide several congestion control schemes, allowing traffic to avoid failed links and nodes.

## **Advantages of Common Channel Signaling over Conventional Signaling:**

- **Faster Call Set-up**

In CCS, high speed signaling networks are used for transferring the call set-up messages resulting in smaller delay times when compared to conventional signaling methods, such as Multi-frequency.

- **Greater trunking (or Queueing) Efficiency**

CCS has shorter call set-up and tear down times that result in less call-holding time, subsequently reducing the traffic on the network. In heavy traffic conditions, high trunking efficiency is obtained.

- **Information Transfer –**

CCS allows the transfer of additional information along with the signaling traffic providing facilities such as caller identification and voice or data identification.

## **Introduction to Mobile IP**

Mobile IP is an open standard, defined by the Internet Engineering Task Force (IETF) RFC 2002, that allows users to keep the same IP address, stay connected, and maintain ongoing applications while roaming between IP networks. Mobile IP is scalable for the Internet because it is based on IP—any media that can support IP can support Mobile IP.

The number of wireless devices for voice or data is projected to surpass the number of fixed devices. Mobile data communication will likely emerge as the technology supporting most communication including voice and video. Mobile data communication will be pervasive in cellular systems such as 3G and in wireless LAN such as 802.11, and will extend into satellite communication. Though mobility may be enabled by link-layer technologies, data crossing networks or different link layers is still a problem. The solution to this problem is a standards-based protocol, Mobile IP.

The purpose of this document is to provide an overview of the Mobile IP technology. This document is not a configuration or design guide. For more detailed information on the presented topics, see the "Related Documents" section.

This document has the following sections:

- Mobile IP Overview
- Components of a Mobile IP Network
- How Mobile IP Works
- Security
- Solution to Network Mobility
- Related Documents

### **Mobile IP Overview**

In IP networks, routing is based on stationary IP addresses, similar to how a postal letter is delivered to the fixed address on the envelope. A device on a network is reachable through normal IP routing by the IP address it is assigned on the network.

The problem occurs when a device roams away from its home network and is no longer reachable using normal IP routing. This results in the active sessions of the device being terminated. Mobile IP was created to enable users to keep the same IP address while traveling to a different network (which may even be on a different wireless operator), thus ensuring that a roaming individual could continue communication without sessions or connections being dropped.

Because the mobility functions of Mobile IP are performed at the network layer rather than the physical layer, the mobile device can span different types of wireless and wireline networks while maintaining connections and ongoing applications. Remote login, remote printing, and file transfers are some examples of applications where it is undesirable to interrupt communications while an individual roams across network boundaries. Also, certain network services, such as software licenses and access privileges, are based on IP addresses. Changing these IP addresses could compromise the network services.

### Components of a Mobile IP Network

Mobile IP has the following three components, as shown in Figure 1:

- Mobile Node
- Home Agent
- Foreign Agent

Figure 1 Mobile IP Components and Relationships

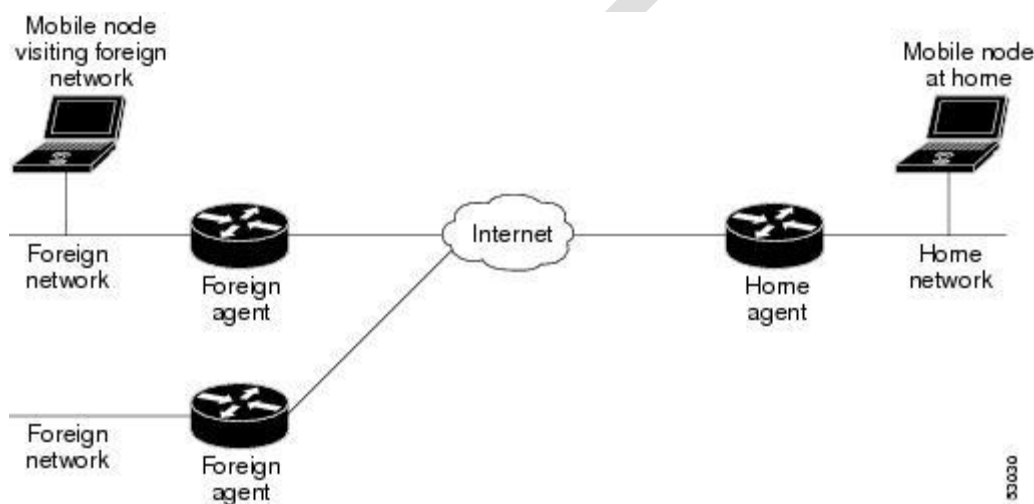

The Mobile Node is a device such as a cell phone, personal digital assistant, or laptop whose software enables network roaming capabilities.

The Home Agent is a router on the home network serving as the anchor point for communication with the Mobile Node; it tunnels packets from a device on the Internet, called a Correspondent Node, to the roaming Mobile Node. (A tunnel is established between the Home Agent and a reachable point for the Mobile Node in the foreign network.)

The Foreign Agent is a router that may function as the point of attachment for the Mobile Node when it roams to a foreign network, delivering packets from the Home Agent to the Mobile Node.

The care-of address is the termination point of the tunnel toward the Mobile Node when it is on a foreign network. The Home Agent maintains an association between the home IP address of the Mobile Node and its care-of address, which is the current location of the Mobile Node on the foreign or visited network

## **How Mobile IP Works**

This section explains how Mobile IP works. The Mobile IP process has three main phases, which are discussed in the following sections.

- **Agent Discovery** : A Mobile Node discovers its Foreign and Home Agents during agent discovery.
- **Registration**: The Mobile Node registers its current location with the Foreign Agent and Home Agent during registration.
- **Tunneling**: A reciprocal tunnel is set up by the Home Agent to the care-of address (current location of the Mobile Node on the foreign network) to route packets to the Mobile Node as it roams.

### **Agent Discovery**

During the agent discovery phase, the Home Agent and Foreign Agent advertise their services on the network by using the ICMP Router Discovery Protocol (IRDP). The Mobile Node listens to these advertisements to determine if it is connected to its home network or foreign network.

The IRDP advertisements carry Mobile IP extensions that specify whether an agent is a Home Agent, Foreign Agent, or both; its care-of address; the types of services it will provide such as reverse tunneling and generic routing encapsulation (GRE); and the allowed registration lifetime or roaming period for visiting Mobile Nodes. Rather than waiting for agent advertisements, a Mobile Node can send out an agent solicitation. This solicitation forces any agents on the link to immediately send an agent advertisement.

If a Mobile Node determines that it is connected to a foreign network, it acquires a care-of address. Two types of care-of addresses exist:

- Care-of address acquired from a Foreign Agent
- Colocated care-of address

A Foreign Agent care-of address is an IP address of a Foreign Agent that has an interface on the foreign network being visited by a Mobile Node. A Mobile Node that acquires this type of care-of address can share the address with other Mobile Nodes. A colocated care-of address is an IP address temporarily assigned to the interface of the Mobile Node itself. A colocated care-of address represents the current position of the Mobile Node on the foreign network and can be used by only one Mobile Node at a time.

When the Mobile Node hears a Foreign Agent advertisement and detects that it has moved outside of its home network, it begins registration.

### **Registration**

The Mobile Node is configured with the IP address and mobility security association (which includes the shared key) of its Home Agent. In addition, the Mobile Node is configured with either its home IP address, or another user identifier, such as a Network Access Identifier.

The Mobile Node uses this information along with the information that it learns from the Foreign Agent advertisements to form a Mobile IP registration request. It adds the registration request to its pending list and sends the registration request to its Home Agent either through the Foreign Agent or directly if it is using a colocated care-of address and is not required to register through the Foreign Agent. If the registration request is sent through the Foreign Agent, the Foreign Agent checks the validity of the registration request, which includes checking that the requested lifetime does not exceed its limitations, the requested tunnel encapsulation is available, and that reverse tunnel is supported. If the registration request is valid, the Foreign Agent adds the visiting Mobile Node to its pending list before relaying the request to the Home Agent. If the registration request is not valid, the Foreign Agent sends a registration reply with appropriate error code to the Mobile Node. The Home Agent checks the validity of the registration request, which includes authentication of the Mobile Node. If the registration request is valid, the Home Agent creates a mobility binding (an association of the Mobile Node with its care-of address), a tunnel to the care-of address, and a routing entry for forwarding packets to the home address through the tunnel.

The Home Agent then sends a registration reply to the Mobile Node through the Foreign Agent (if the registration request was received via the Foreign Agent) or directly to the Mobile Node. If the registration request is not valid, the Home Agent rejects the request by sending a registration reply with an appropriate error code.

The Foreign Agent checks the validity of the registration reply, including ensuring that an associated registration request exists in its pending list. If the registration reply is valid, the Foreign Agent adds the Mobile Node to its visitor list, establishes a tunnel to the Home Agent, and creates a routing entry for forwarding packets to the home address. It then relays the registration reply to the Mobile Node.

Finally, the Mobile Node checks the validity of the registration reply, which includes ensuring an associated request is in its pending list as well as proper authentication of the Home Agent. If the registration reply is not valid, the Mobile Node discards the reply. If a valid registration reply specifies that the registration is accepted, the Mobile Node is confirmed that the mobility agents are aware of its roaming. In the colocated care-of address case, it adds a tunnel to the Home Agent. Subsequently, it sends all packets to the Foreign Agent.

The Mobile Node reregisters before its registration lifetime expires. The Home Agent and Foreign Agent update their mobility binding and visitor entry, respectively, during reregistration. In the case where the registration is denied, the Mobile Node makes the necessary adjustments and attempts to register again. For example, if the registration is denied because of time mismatch and the Home Agent sends back its time stamp for synchronization, the Mobile Node adjusts the time stamp in future registration requests.

Thus, a successful Mobile IP registration sets up the routing mechanism for transporting packets to and from the Mobile Node as it roams.

## **Tunneling**

The Mobile Node sends packets using its home IP address, effectively maintaining the appearance that it is always on its home network. Even while the Mobile Node is roaming on foreign networks, its movements are transparent to correspondent nodes.

Data packets addressed to the Mobile Node are routed to its home network, where the Home Agent now intercepts and tunnels them to the care-of address toward the Mobile Node. Tunneling has two primary functions: encapsulation of the data packet to reach the tunnel endpoint, and decapsulation when the packet is delivered at that endpoint. The default tunnel mode is IP Encapsulation within IP Encapsulation. Optionally, GRE and minimal encapsulation within IP may be used.

Typically, the Mobile Node sends packets to the Foreign Agent, which routes them to their final destination, the Correspondent Node, as shown in Figure 2.

Figure 2 Packet Forwarding

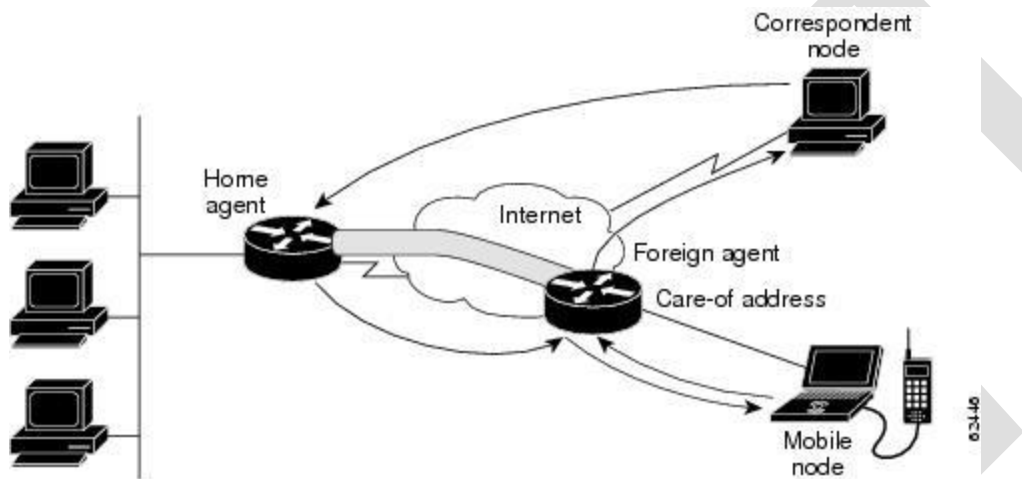

However, this data path is topologically incorrect because it does not reflect the true IP network source for the data—rather, it reflects the home network of the Mobile Node. Because the packets show the home network as their source inside a foreign network, an access control list on routers in the network called ingress filtering drops the packets instead of forwarding them. A feature called reverse tunneling solves this problem by having the Foreign Agent tunnel packets back to the Home Agent when it receives them from the Mobile Node. See Figure 3.

Figure 3 Reverse Tunnel

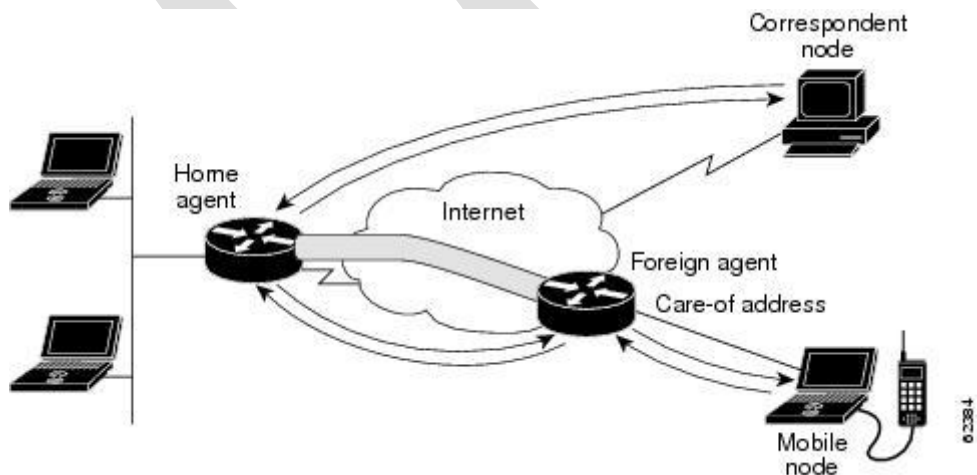



Tunnel MTU discovery is a mechanism for a tunnel encapsulator such as the Home Agent to participate in path MTU discovery to avoid any packet fragmentation in the routing path between a Correspondent Node and Mobile Node. For packets destined to the Mobile Node, the Home Agent maintains the MTU of the tunnel to the care-of address and informs the Correspondent Node of the reduced packet size. This improves routing efficiency by avoiding fragmentation and reassembly at the tunnel endpoints to ensure that packets reach the Mobile Node.

## **Security**

Mobile IP uses a strong authentication scheme for security purposes. All registration messages between a Mobile Node and Home Agent are required to contain the Mobile-Home Authentication Extension (MHAE).

The integrity of the registration messages is protected by a preshared 128-bit key between a Mobile Node and Home Agent. The keyed message digest algorithm 5 (MD5) in "prefix+suffix" mode is used to compute the authenticator value in the appended MHAE, which is mandatory. Mobile IP also supports the hash-based message authentication code (HMAC-MD5). The receiver compares the authenticator value it computes over the message with the value in the extension to verify the authenticity.

Optionally, the Mobile-Foreign Authentication Extension and Foreign-Home Authentication Extension are appended to protect message exchanges between a Mobile Node and Foreign Agent and between a Foreign Agent and Home Agent, respectively.

Replay protection uses the identification field in the registration messages as a timestamp and sequence number. The Home Agent returns its time stamp to synchronize the Mobile Node for registration.

Cisco IOS software allows the mobility keys to be stored on an authentication, authorization, and accounting (AAA) server that can be accessed using TACACS+ or RADIUS protocols. Mobile IP in Cisco IOS software also contains registration filters, enabling companies to restrict who is allowed to register.

## **Solution to Network Mobility**

Network mobility is enabled by Mobile IP, which provides a scalable, transparent, and secure solution. It is scalable because only the participating components need to be Mobile IP aware—the Mobile Node and the endpoints of the tunnel. No other routers in the network or any hosts with which the Mobile Node is communicating need to be changed or even aware of the movement of the Mobile Node. It is transparent to any applications while providing mobility. Also, the network layer provides link-layer independence, interlink layer roaming, and link-layer transparency. Finally, it is secure because the set up of packet redirection is authenticated.

## **Related Documents**

- *Cisco IOS IP Command Reference, Volume 1 of 3: Addressing and Services*, Release 12.2
- *Cisco IOS IP Configuration Guide*, Release 12.2

Just as most of us have only a single address used for our mail, most IP devices have only a single address. Our traveling consultant, however, needs to have two addresses; a normal one and one that is used while he is away. Continuing our [earlier analogy](#), the Mobile-IP-equipped notebook our consultant carries needs to have two addresses as well:

- **Home Address:** The “normal”, permanent IP address assigned to the mobile node. This is the address used by the device on its home network, and the one to which datagrams intended for the mobile node are always sent.
- **Care-Of Address:** A secondary, temporary address used by a mobile node while it is 'traveling" away from its home network. It is a normal 32-bit IP address in most respects, but is used only by Mobile IP for forwarding IP datagrams and for administrative functions. Higher layers never use it, nor do regular IP devices when creating datagrams.

### *Mobile IP Care-Of Address Types*

The care-of address is a slightly tricky concept. There are two different types, which correspond to two distinctly different methods of forwarding datagrams from the home agent router.

### **Foreign Agent Care-Of Address**

This is a care-of address provided by a foreign agent in its *Agent Advertisement* message. It is, in fact, the IP address of the foreign agent itself. When this type of care-of address is used, all datagrams captured by the home agent are not relayed directly to the mobile node, but indirectly to the foreign agent, which is responsible for final delivery. Since in this arrangement the mobile node has no distinct IP address valid on the foreign network, this is typically done using a layer two technology. This arrangement is illustrated in [Figure 129](#).

In our consultant analogy, this type of care-of address is like forwarding from the London post office to the Tokyo post office. The London personnel would take a letter for John Smith sent to his London address, and repackage it for delivery to “John Smith, care of the Tokyo post office”. The Tokyo post office (or John Smith himself) would need to worry about the last leg of the delivery.

## Co-Located Care-Of Address

This is a care-of address assigned directly to the mobile node using some means external to Mobile IP. For

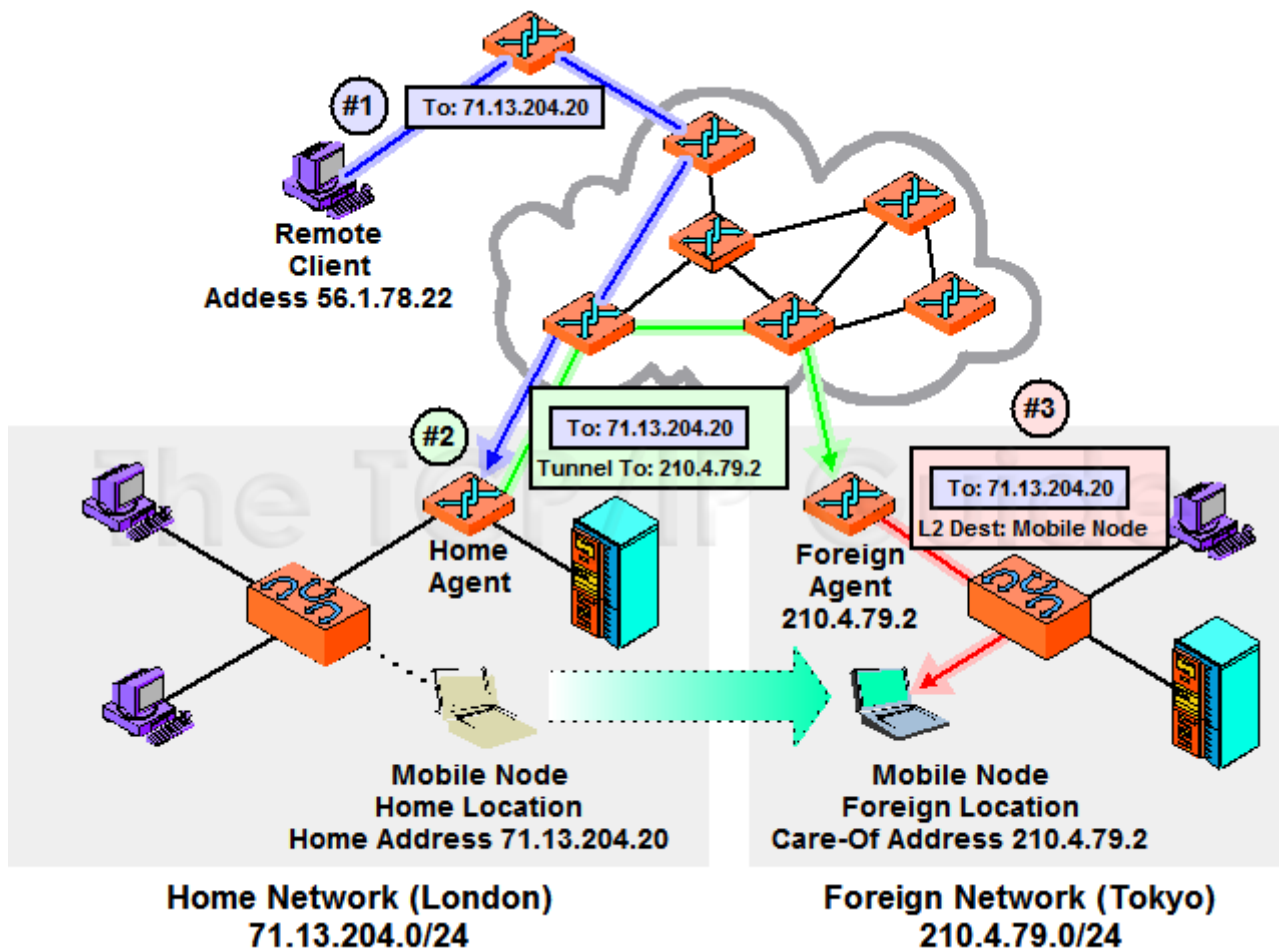

**Figure 129: Mobile IP Operation With A Foreign Agent “Care-Of” Address**

This diagram is similar to [Figure 128](#), except that instead of the mobile node having a co-located (distinct) address as in that example, here the mobile node is using a foreign agent care-of address. This means the mobile node's care-of address is actually that of the foreign agent itself. Step #1 is the same as in [Figure 128](#), but in step #2 the home agent forwards not to the mobile node directly, but to the foreign agent (since that router is the one with the IP address the mobile is using). In step #3 the foreign agent strips off the home agent's packaging and delivers the original datagram to the mobile node. This is typically done using whatever layer two (LAN or wireless) technology connects the mobile node and foreign agent together.

For example, it may be assigned on the foreign network manually, or automatically using [DHCP](#). In this situation, the care-of address is used to forward traffic from the home agent directly to the mobile node. This was the type of address shown in [Figure 128](#).

## *Advantages and Disadvantages of the Care-Of Address Types*

The foreign agent care-of address is considered the type used in “classical” Mobile IP, where there is both a home agent and a foreign agent. While it seems less efficient than the co-located address method, it offers some important advantages. A key one is that the same foreign agent care-of address can be used for all mobile nodes visiting that network. Datagrams for all mobile nodes on that network are sent to the foreign agent, which completes the delivery to the individual nodes. Since the mobile nodes use the foreign agent's address, no extra addresses or extra work are required for each mobile node.

The co-located care-of address has the advantage that traffic can be forwarded directly from the home agent to the mobile node. In this type of arrangement, it is possible for a Mobile IP device to travel to a foreign network where there is no Mobile-IP-aware router to act as a foreign agent. This does mean, however, that the Mobile IP implementation must include all the functions of communicating with the home agent that the foreign agent normally performs.

When co-located care-of addresses are used, an issue is how the temporary address is obtained. In many foreign networks automatic assignment of an IP address using something like DHCP may be possible, but if not, a temporary IP address would need to be assigned. Either way, some of the foreign network's limited IP address space would need to be set aside for mobile nodes, each of which would use an address while present on the network. In some cases this could lead to an address depletion issue.

Foreign agent care-of addressing is usually preferred due to its more automatic nature, when a foreign agent is present on the visited network. Considering that all datagrams will need to go through some router on the foreign network to reach the mobile node anyway, we might as well save the extra IP addresses. Co-located care-of addresses would be used when there is no foreign agent, or might be practical for long term connections even when a foreign agent is present.

Remember that the care-of address represents only the destination to which mobile node datagrams are forwarded. Foreign agents provide services other than forwarding, so it is possible for a mobile node to use a co-located care-of address even when a foreign agent is present, while continuing to take advantage of the other foreign agent services.

 **Key Concept:** In Mobile IP, co-located care-of addresses have the advantage of flexibility, but require each device to have a unique IP address on the remote network. Foreign agent care-of addresses have the chief advantage of allowing many mobile devices on a foreign network without each requiring a distinct IP address.

For more information on how datagrams are forwarded between the home agent and the mobile node's care-of address, see [the topic on Mobile IP encapsulation and tunneling](#).

Once a mobile node on a foreign network has completed a successful [registration](#) with its home agent, the Mobile IP datagram forwarding process described in [the general operation topic](#) will be fully “activated”. The home agent will intercept datagrams intended for the mobile node as they are routed to its home network, and forward them to the mobile node. This is done by *encapsulating* the datagrams and then sending them to the node's care-of address.

## *Mobile IP Data Encapsulation Techniques*

Encapsulation is required because each datagram we intercept and forward needs to be resent over the network to the device's care-of address. In theory, the designers might conceivably have done this by just having the home agent change the destination address and stick it back out on the network, but there are various complications that make this unwise. It makes more sense to take the entire datagram and wrap it in a new set of headers before retransmitting. In our [mail analogy](#), this is comparable to taking a letter received for our traveling consultant and putting it into a fresh envelope for forwarding, as opposed to just crossing off the original address and putting a new one on.

The default encapsulation process used in Mobile IP is called *IP Encapsulation Within IP*, defined in RFC 2003 and commonly abbreviated *IP-in-IP*. It is a relatively simple method that describes how to take an IP datagram and make it the payload of another IP datagram. In Mobile IP, the new headers specify how to send the encapsulated datagram to the mobile node's care-of address.

In addition to IP-in-IP, two other encapsulation methods may be optionally used: *Minimal Encapsulation Within IP*, defined in RFC 2004, and *Generic Routing Encapsulation (GRE)*, defined in RFC 1701. To use either of these, the mobile node must request the appropriate method in its *Registration Request* and the home agent must agree to use it. If foreign agent care-of addressing is used, the foreign agent also must support the method desired.

## *The Mobile IP Data Delivery Tunnel*

The encapsulation process creates a logical construct called a *tunnel* between the device that encapsulates and the one that decapsulates. This is the same idea of a tunnel used in discussions of virtual private networks (VPNs), [IPSec tunnel mode](#), or the various other tunneling protocols used for security. The tunnel represents a conduit over which datagrams are forwarded across an arbitrary internetwork, with the details of the encapsulated datagram (meaning the original IP headers) temporarily hidden.

In Mobile IP, the start of the tunnel is the home agent, which does the encapsulation. The end of the tunnel depends on what sort of care-of address is being used:

- **Foreign Agent Care-Of Address:** The foreign agent is the end of the tunnel. It receives encapsulated messages from the home agent, strips off the outer IP header and then delivers the datagram to the mobile node. This is generally done using layer two, because the mobile node and foreign agent are on the same local network, and of course, the mobile node does not have its own IP address on that network (it is using that of the foreign agent.)
- **Co-Located Care-Of Address:** The mobile node itself is the end of the tunnel and strips off the outer header.

## WAP

WAP is an international standard establishing how mobile devices can access information on the Internet.

It is a widely used set of protocols used on wireless devices such as mobile phones and PDAs.

[WAP is] the de facto worldwide standard for providing Internet communications and advanced telephony services on digital mobile phones, pagers, personal digital assistants and other wireless terminals - *WAP Forum*

WAP stands for **Wireless Application Protocol**. Per the dictionary definition for each of these words, we have:

- **Wireless:** Lacking or not requiring a wire or wires: pertaining to radio transmission.
- **Application:** A computer program or piece of computer software that is designed to do a specific task.
- **Protocol:** A set of technical rules about how information should be transmitted and received using computers.

WAP is the set of rules governing the transmission and reception of data by computer applications on, or via, wireless devices like mobile phones. WAP allows wireless devices to view specifically designed pages from the Internet, using only plain text and very simple black-and-white pictures.

WAP is a standardized technology for cross-platform, distributed computing, very similar to the Internet's combination of Hypertext Markup Language (HTML) and Hypertext Transfer Protocol (HTTP), except that it is optimized for:

- low-display capability
- low-memory
- low-bandwidth devices, such as personal digital assistants (PDAs), wireless phones, and pagers.

WAP is designed to scale across a broad range of wireless networks, like GSM, IS-95, IS-136 and PDC.

### ***Who is behind WAP?***

The Wireless Application Protocol (WAP) is a result of joint efforts taken by companies teaming up in an industry group called WAP Forum ([www.wapforum.org](http://www.wapforum.org)).

On June 26 1997 Ericsson, Motorola, Nokia, and Unwired Planet took the initiative to start a rapid creation of a standard for making advanced services within the wireless domain a reality. In December 1997 WAP Forum was formally created, and after the release of the WAP 1.0 specifications in April 1998, WAP Forum membership was opened to all.

The WAP Forum now has over 500 members and represents over 95 percent of the global handset market. Companies such as Nokia, Motorola and Ericsson are all members of the forum.

The objective of the forum is to create a license-free standard that brings information and telephony services to wireless devices.

## ***Why is WAP Important?***

Until the first WAP devices emerged, the Internet was the Internet and a mobile phone was a mobile phone. You could surf the Net, do serious research, or be entertained on the Internet using your computer. But this was limited to your computer.

Now with the appearance of WAP, the scene is that we have the massive information, communication, and data resources of the Internet becoming more easily available to anyone with a mobile phone or communications device.

WAP, being open and secure, is well suited for many different applications, including but not limited to stock market information, weather forecasts, enterprise data and games.

Despite the common misconception, developing WAP applications requires only a few modifications to existing web applications. The current set of web application development tools will easily support WAP development, and in the future more development tools will be announced.

### ***WAP Microbrowser:***

To browse a standard internet site you need a web browser. Similar way to browse a WAP enabled website you would need a micro browser. A Micro Browser is a small piece of software that makes minimal demands on hardware, memory and CPU. It can display information written in a restricted mark-up language called WML. Although tiny in memory footprint, it supports many features and is even scriptable.

Today, all the WAP enabled mobile phones or PDAs are equipped with these micro browsers so that you can take full advantage of WAP technology.

There are listed some of the key features offered by WAP:

### ***A programming model similar to the Internet's:***

Though WAP is a new technology but it reuse the concepts found on the Internet. This reuse enables a quick introduction of WAP-based services, since both service developers and manufacturers are familiar with these concepts today.

### ***Wireless Markup Language (WML):***

You must be using HTML language to develop your web based application. Same way WML is a markup language used for authoring WAP services, fulfilling the same purpose as HTML does on the Web. In contrast to HTML, WML is designed to fit small handheld devices.

### ***WMLScript:***

Once again, you must be using Java Script or VB script to enhance the functionality of your web applications. Same way WMLScript can be used to enhance the functionality of a service, just as, Java script can be utilized in HTML. It makes it possible to add procedural logic and computational functions to WAPbased services.

### ***Wireless Telephony Application Interface (WTAI):***

The WTAI is an application framework for telephony services. WTAI user agents are able to make calls and edit the phone book by calling special WMLScript functions or by accessing special URLs. If one writes WML decks containing names of people and their phone numbers, you may add them to your phone book or call them right away just by clicking the appropriate hyperlink on the screen.

### ***Optimized protocol stack:***

The protocols used in WAP are based on well-known Internet protocols, such as HTTP and Transmission Control Protocol (TCP), but they have been optimized to address the constraints of a wireless environment, such as low bandwidth and high latency.

Before we describe WAP model, first we would like you to understand how Standard Internet works.

### ***The Internet Model:***

The Internet model makes it possible for a client to reach services on a large number of origin servers; each addressed by a unique Uniform Resource Locator (URL).

The content stored on the servers is of various formats, but HTML is the predominant. HTML provides the content developer with a means to describe the appearance of a service in a flat document structure. If more advanced features like procedural logic are needed, then scripting languages such as JavaScript or VB Script may be utilised.

The figure below shows how a WWW client request a resource stored on a web server. On the Internet, standard communication protocols, like HTTP and Transmission Control Protocol/Internet Protocol (TCP/IP) are used.

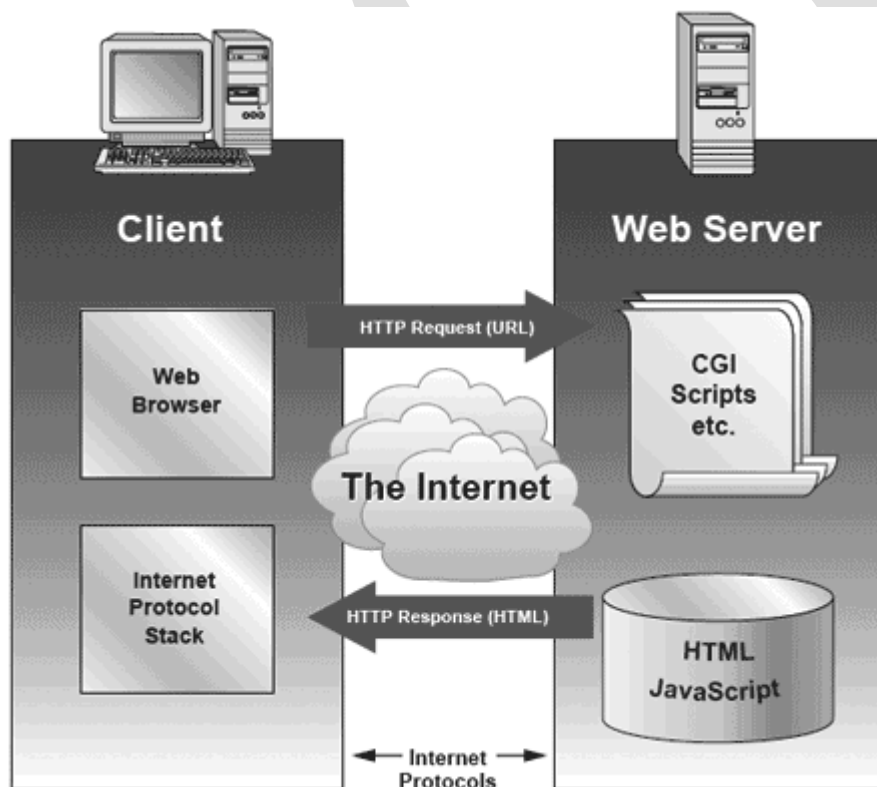



The content available at the web server may be static or dynamic. Static content is produced once and not changed or updated very often, for example a company presentation. Dynamic content is needed when the information provided by the service changes more often, for example timetables, news, stock quotes and account information. Technologies such as Active Server Pages (ASP), Common Gateway Interface (CGI), and Servlets allow content to be generated dynamically.

### ***The WAP Model:***

The figure below shows the WAP programming model. Note the similarities with the Internet model. Without the WAP Gateway/Proxy the two models would have been practically identical.

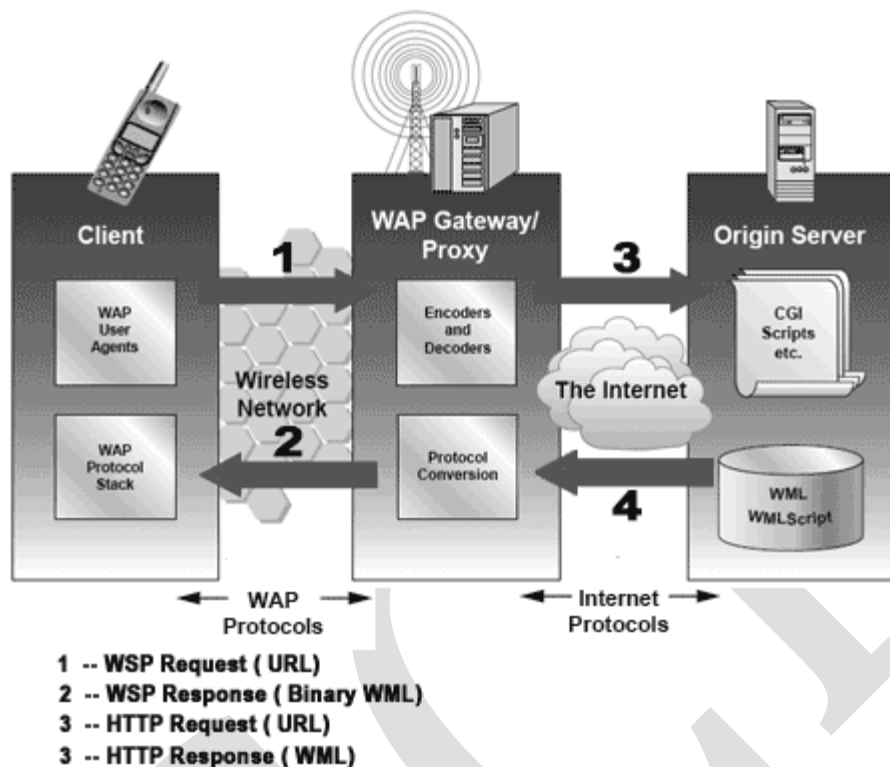

WAP Gateway/Proxy is the entity that connects the wireless domain with the Internet. You should make a note that the request that is sent from the wireless client to the WAP Gateway/Proxy uses the Wireless Session Protocol (WSP). In its essence, WSP is a binary version of HTTP.

A markup language - the Wireless Markup Language (WML) has been adapted to develop optimized WAP applications. In order to save valuable bandwidth in the wireless network, WML can be encoded into a compact binary format. Encoding WML is one of the tasks performed by the WAP Gateway/Proxy.

### ***How WAP Model Works?***

When it comes to actual use, WAP works like this:

1. The user selects an option on their mobile device that has a URL with Wireless Markup language (WML) content assigned to it.
2. The phone sends the URL request via the phone network to a WAP gateway, using the binary encoded WAP protocol.
3. The gateway translates this WAP request into a conventional HTTP request for the specified URL, and sends it on to the Internet.

4. The appropriate Web server picks up the HTTP request.
5. The server processes the request, just as it would any other request. If the URL refers to a static WML file, the server delivers it. If a CGI script is requested, it is processed and the content returned as usual.
6. The Web server adds the HTTP header to the WML content and returns it to the gateway.
7. The WAP gateway compiles the WML into binary form.
8. The gateway then sends the WML response back to the phone.
9. The phone receives the WML via the WAP protocol.
10. The micro-browser processes the WML and displays the content on the screen.

## - Architecture

WAP is designed in a layered fashion so that it can be extensible, flexible, and scalable. As a result, the WAP protocol stack is divided into five layers:

- **Application Layer**  
Wireless Application Environment (WAE). This layer is of most interest to content developers because it contains, among other things, device specifications and the content development programming languages, WML and WMLScript.
- **Session Layer**  
Wireless Session Protocol (WSP). Unlike HTTP, WSP has been designed by the WAP Forum to provide fast connection suspension and reconnection.
- **Transaction Layer**  
Wireless Transaction Protocol (WTP). The WTP runs on top of a datagram service such as User Datagram Protocol (UDP) and is part of the standard suite of TCP/IP protocols used to provide a simplified protocol suitable for low bandwidth wireless stations.
- **Security Layer**  
Wireless Transport Layer Security (WTLS). WTLS incorporates security features that are based upon the established Transport Layer Security (TLS) protocol standard. It includes data integrity checks, privacy, service denial, and authentication services.
- **Transport Layer**  
Wireless Datagram Protocol (WDP). The WDP allows WAP to be bearer-independent by adapting the transport layer of the underlying bearer. The WDP presents a consistent data format to the higher layers of the WAP protocol stack, thereby offering the advantage of bearer independence to application developers.

Each of these layers provides a well-defined interface to the layer above it. This means that the internal workings of any layer are transparent or invisible to the layers above it. The layered architecture allows other applications and services to utilise the features provided by the WAP-stack as well. This makes it possible to use the WAP-stack for services and applications that currently are not specified by WAP.

The WAP protocol architecture is shown below alongside a typical Internet Protocol stack.

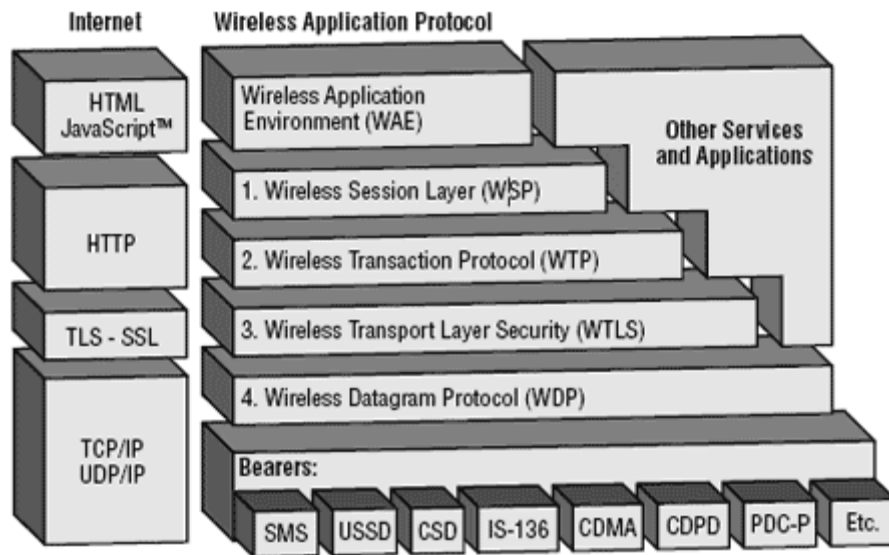

Note that the mobile network bearers in the lower part of the figure above are not part of the WAP protocol stack.

## WAP – Environment

The uppermost layer in the WAP stack, the Wireless Application Environment (WAE) provides an environment that enables a wide range of applications to be used on wireless devices. In the chapter "WAP - the wireless service enabler" the WAP WAE programming model was introduced. This chapter will focus on the various components of WAE:

- **Addressing model**

A syntax suitable for naming resources stored on servers. WAP use the same addressing model as the one used on the Internet, that is, Uniform Resource Locators (URL).

- **Wireless Markup Language (WML)**

A lightweight markup language designed to meet the constraints of a wireless environment with low bandwidth and small handheld devices. The Wireless Markup Language is WAP.s analogy to HTML used on the WWW. WML is based on the Extensible Markup Language (XML).

- **WML Script**

A lightweight scripting language. WML Script is based on ECMA Script, the same scripting language that JavaScript is based on. It can be used for enhancing services written in WML in the way that it to some extent adds intelligence to the services, for example procedural logic, loops, conditional expressions, and computational functions.

- **Wireless Telephony Application (WTA, WTAI)**

A framework and programming interface for telephony services. The Wireless Telephony Application (WTA) environment provides a means to create telephony services using WAP.

### *Hardware and Software Requirement:*

At minimum, developing WAP applications requires a web server and a WAP simulator. Using simulator software while developing a WAP application is convenient as all the required software can be installed on the development PC.

Although software simulators are good in their own right, no WAP application should go into production without testing it with actual hardware. The following list gives a quick overview of the necessary hardware and software to test and develop WAP applications:

- a Web server with connection to the Internet
- a WML to develop WAP application
- a WAP simulator to test WAP application
- a WAP gateway
- a WAP phone for final testing

Microsoft IIS or Apache on Windows or Linux can be used as the web server and Nokia WAP Toolkit version 2.0 as the WAP simulator.

Please have look at [WAP - Useful Resources](#) to find out all the above components.

### ***Configure Web Server for WAP:***

In the WAP architecture, the web server communicates with the WAP gateway, accepting HTTP requests and returning WML code to the gateway. The HTTP protocol mandates that each reply must include something called a Multi-Purpose Internet Mail Extensions (MIME) type.

In normal web applications, this MIME type is set to text/html, designating normal HTML code. Images, on the other hand, could be specified as image/gif or image/jpeg, for instance. With this content type specification, the web browser knows the data type that the web server returns.

In WAP applications a new set of MIME types must be used, as shown in the following table:

<b>File type</b>	<b>MIME type</b>
WML (.wml)	text/vnd.wap.wml
WMLScript (.wmls)	text/vnd.wap.wmlscript
WBMP (.wbmp)	image/vnd.wap.wbmp

In dynamic applications, the MIME type must be set on the fly, whereas in static WAP applications the web server must be configured appropriately.

For more information about configuring MIME types for your web server, please consult your web server documentation.

**WAP - WML Syntax**The topmost layer in the WAP architecture is made up of WAE (Wireless Application Environment), which consists of WML and WML scripting language.

WML scripting language is used to design applications that are sent over wireless devices such as mobile phones. This language takes care of the small screen and the low bandwidth of transmission. WML is an application of XML, which is defined in a document-type definition.

WML pages are called decks. They are constructed as a set of cards, related to each other with links. When a WML page is accessed from a mobile phone, all the cards in the page are downloaded from the WAP server to mobile phone showing the content.

WML commands and syntaxes are used to show content and to navigate between the cards. Developers can use these commands to declare variables, format text, and show images on the mobile phone.

### WAP - Core Services

A vast majority of WAP services are available in the market. You may to contact to some WAP lover to have a big list of all the available services and then you can start accessing those services from your WAP enabled mobile phone.

However, some examples of useful mobile services are in the following fields:

#### ***Banking:***

- Accessing account statements
- Paying bills
- Transferring money between accounts

#### ***Finance:***

- Retrieving stock and share prices
- Buying and selling stocks and shares
- Looking up interest rates
- Looking up currency exchange rates

#### ***Shopping:***

- Buying everyday commodities
- Browsing and buying books
- Buying CDs

#### ***Ticketing:***

- Booking or buying airline tickets
- Buying concert tickets
- Booking theatre tickets

#### ***Entertainment:***

- Retrieving restaurant details
- Looking up clubs
- Finding out what is playing in what cinemas
- Playing solitaire games
- Playing interactive games

### ***Weather:***

- Retrieving local weather forecasts
- Looking up weather at other locations

### ***E- Messaging:***

- Voice mail
- Unified Messaging
- Enhanced support of legacy SMS services

### **Live WAP Examples:**

The following are some example WAP applications:

- **123Jump** (<http://www.123jump.com>) A selection of stock data and news, all via WAP.
- **1477.com** (<http://1477.com>) WAP/Web development services.
- **2PL World-Wide Hotel Guide** (<http://wap.2pl.com>) A worldwide hotel guide, accessible in multiple languages via a WAP-enabled device.
- **AEGEE-Eindhoven** (<http://wappy.to/aegee/>) A Europe-wide students' association whose goal is to allow all students to integrate and learn about each others' cultures.
- **Ajaxo** (<http://www.ajaxo.com>) A WAP service for Wireless Stock Trading from any WAP-enabled device.
- **Aktiesidan** (<http://mmm.aktiesidan.com/servlets/aktiesidan/>) A Swedish stock-market monitoring service, all WAP-enabled.
- **Amazon.com Bookshop** (<http://www.amazon.com/phone/>) Amazon.com has launched this WAP portal (HDML-based) for browsing books.
- **Traffic Maps** (<http://www.webraska.com/>) A French service that monitors and shows the latest in traffic news via maps.

### **WAP - Key Benefits**

The following sections outline how various groups may gain from WAP:

#### ***Subscribers:***

It is crucial that the subscribers will benefit from using WAP based services, otherwise there will be no incentive neither for WAP as a whole nor for any of the other groups mentioned below. The key-benefits can be summarized as:

- Portability
- Easy to use
- Access to a wide variety of services on a competitive market
- The possibility of having personalized services
- Fast, convenient, and efficient access to services
- To fulfill as many customers needs as possible, WAP devices will be available in various form factors, e.g. pagers, handheld PCs, and phones

### ***Operators:***

Many of the advantages mentioned under "Service Providers" are applicable to operators as well. The operator's benefits may include:

- Address new market segments of mobile users by enabling a wider range of mobile VAS.
- Deploy telephony services that in contrast to traditional telephony services are easy to create, update, and personalize
- Use the flexibility of WAP as a tool to differentiate from competitors
- Attractive interface to services will increase usage
- Increased revenues per user due to higher network utilization
- Convenient service creation and maintenance, including short time-to-market
- Replace expensive customer care centers with WAP based services (E-care)
- WAP services are designed to be independent of the network, implying that an operator who runs different types of networks only have to develop its services ones
- An open standard means that equipment will be provided by many manufacturers

### ***Service Providers:***

WAP opens new possibilities for service and content providers since they not necessarily have to come to an agreement with a specific operator about providing services to their customers. The gains are for example:

- Create a service once, make it accessible on a broad range of wireless networks
- Address new market segments by launching innovative mobile VAS. Keep old customers by adapting existing Internet services to WAP
- Keep old customers by adapting existing Internet services to WAP
- Convenient service creation and maintenance
- Creating a WAP service is no harder than creating an Internet service today since WML and WMLScript are based on well-known Internet technology
- Use standard tools like ASP or CGI to generate content dynamically
- Utilise existing investments in databases etc that are the basis of existing Internet services

### ***Manufacturers:***

Mobile devices supporting WAP will be available in many different form factors, e.g. cellular phones, pagers, and handheld PCs. Hardware manufacturers will also need to supply operators etc with equipment, such as WAP Gateway/Proxy and WTA servers. Manufacturer benefits are for example:

- WAP scales across a broad range of mobile networks, meaning that WAP implementations can be used in devices supporting different types of networks.
- The expected wide adoption of WAP implies that economies of scales can be achieved, meaning that the huge mass-market can be addressed
- The fact that WAP is designed to consume minimal amount of memory, and that the use of proxy technology relieves the CPU, means that inexpensive components can be used in the handsets
- Reuse the deep knowledge about wireless network infrastructure to develop advanced servers that seamlessly integrates mobile VAS with telephony
- Seize the opportunity to introduce new innovative products

## ***Tools Providers:***

Today there is a large amount of tools available for creating applications for the web. Content developers have become used to the convenience that tools like FrontPage and Dream Weaver provides. Tools providers will be able to:

- Reuse and modify existing products to support WAP, or even integrate WAP support in existing tools.
- Address a new customer base in the wireless community.

## **WAP - Modern Devices**

A WAP device is a combination of hardware and software capable of running a WAP-compliant micro browser such as a WAP-enabled mobile phone or a PDA.

APC can also be used as a WAP device if you download a WAP phone emulator from one of the developer sites. The emulator allows you to use a virtual phone on your desktop. Some major suppliers, such as Ericsson, Nokia, and Open wave, have developer sites where you can download software development kits (SDKs) containing WAP emulators.

A WAP phone can run any WAP application in the same way that a Web browser can run any HTML application. Once you have a WAP phone, you can access the Internet simply by entering URLs and following the links that appear.

Using these devices, easy and secure access to Internet content and services such as banking, leisure, and unified messaging is made available. Furthermore, access is not restricted to the Internet; WAP devices will be able to deal with intranet information in the same way as Internet content because both are based upon HTML.

Following is a selection of WAP phones that have been announced recently:

## **WAP Enabled Phones on SALE**

### **WAP - Future Prospects**

The future of WAP depends largely on whether consumers decide to use WAP devices to access the Web, and also on whether a new technology comes along that would require a different infrastructure than WAP.

On the consumer side, the factors largely involve the limitations of WAP and of handheld devices: the low bandwidth, the limited input ability, and the small screens all require users to adapt from their regular Web-browsing expectations.

In the next few years, mobile phones will start to benefit from very high bandwidth capabilities. The 2.5G/3G systems will allow much higher capacity and data rates than can be offered by the restricted bandwidth currently available.

These wireless devices will be supported by a number of emerging technologies, including GPRS, EDGE, HSCSD and UMTS:



So what is the future for WAP? It has been designed to be independent of the underlying network technology. The original constraints WAP was designed for - intermittent coverage, small screens, low power consumption, wide scalability over bearers and devices, and one-handed operation - are still valid in 2.5G and 3G networks.

The bottom line is that WAP is not and can never be the Web on your mobile phone. WAP is great as long as developers understand that it's what's inside the applications that matters, and the perceived value of the content to the user. The browser interface itself, while important, will always be secondary to the content.

### **What is Next?**

Now you have basic understanding on WAP. The next step after WAP can be to learn any of the following technologies.

#### ***GPRS (General Packet Radio System):***

A packet-switched wireless protocol with transmission rates from 115Kbps to 171Kbps. It will be the first service available to offer full instant wireless access to the Web. A main benefit is that users are always connected and online, and will be charged only for the amount of data that is transported.

For GSM providers, this new technology will increase data rates of both circuit switching (High Speed Circuit Switched Data [HSCSD]) and packet switching (GPRS) by a factor of 10 to 15 times.

#### ***EDGE (Enhanced Data Rate for GSM Evolution):***

A higher bandwidth version of GPRS with speeds of up to 384Kbps, or twice that available from GPRS alone.

It evolved from GSM, which is the prevailing standard throughout Europe and the Asia Pacific region.

For GSM providers, this new technology will increase data rates of both circuit switching (HSCSD) and packet switching (GPRS) by a factor of 20 to 30 times.

#### ***HSCSD (High Speed Circuit Switched Data):***

A new high-speed implementation of GSM data techniques. It uses four radio channels simultaneously and will enable users to access the Internet via the GSM network at very much higher data rates than at present. Data rates can be transmitted at 38.4Kbps or even faster over GSM networks.

#### ***UMTS (Universal Mobile Telecommunications System):***

UMTS will allow a future mass market for high-quality wireless multimedia communications that will approach two billion users worldwide by the year 2010.

This new technology will deliver low-cost, high-capacity wireless communications, offering data rates of 1Mbps to 2Mbps with global roaming and other advanced UMTS services.

Now, if you need more detail about WAP technology then I would recommend you to go through other WAP resources listed in [WAP Useful Resources](#) chapter.

## 8. Additional topics:

### BLUETOOTH TECHNIQUES:

- Universal short-range wireless capability
- Uses 2.4-GHz band
- Available globally for unlicensed users
- Devices within 10 m can share up to 720 kbps of capacity
- Supports open-ended list of applications  
Data, audio, graphics, video

### Bluetooth Standards Documents:

- Core specifications
  - Details of various layers of Bluetooth protocol architecture
- Profile specifications
  - Use of Bluetooth technology to support various applications

### Protocol Architecture:

- Bluetooth is a layered protocol architecture
  - Core protocols
    - Cable replacement and telephony control protocols
    - Adopted protocols
  - Core protocols
    - Radio
    - Baseband
    - Link manager protocol (LMP)
    - Logical link control and adaptation protocol (L2CAP)
    - Service discovery protocol (SDP)

### Usage Models:

- File transfer
- Internet bridge
- LAN access
- Synchronization
- Three-in-one phone
- Headset

## Piconets and Scatternets:

### ■ Piconet

- Basic unit of Bluetooth networking
- Master and one to seven slave devices
- Master determines channel and phase

### ■ Scatternet

- Device in one piconet may exist as master or slave in another piconet
- Allows many devices to share same area
- Makes efficient use of bandwidth

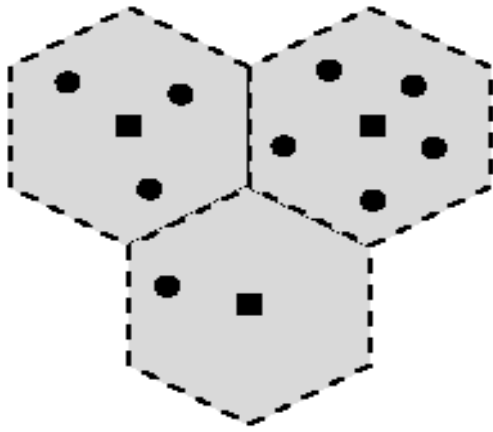

(a) Cellular system (squares represent stationary base stations)

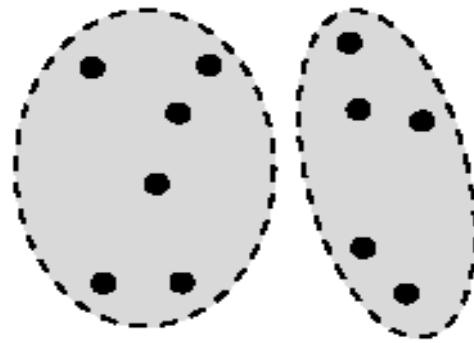

(b) Conventional ad hoc systems

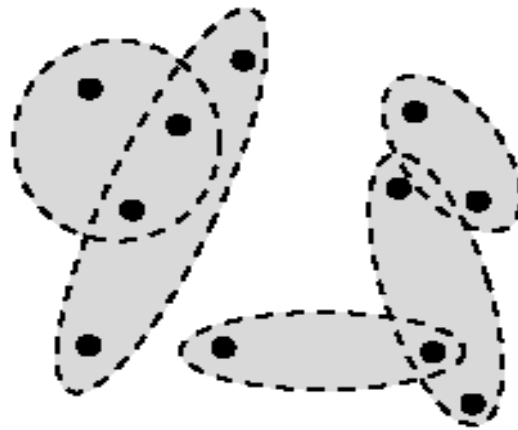

(c) Scatternets

**Figure 15.5 Wireless Network Configurations**

Frequency Hopping in Bluetooth:

- Provides resistance to interference and multipath effects
- Provides a form of multiple access among co-located devices in different piconets .

Frequency Hopping:

- Total bandwidth divided into 1MHz physical channels
- FH occurs by jumping from one channel to another in pseudorandom sequence
- Hopping sequence shared with all devices on piconet

- Piconet access:
  - Bluetooth devices use time division duplex (TDD)
  - Access technique is TDMA
  - FH-TDD-TDMA

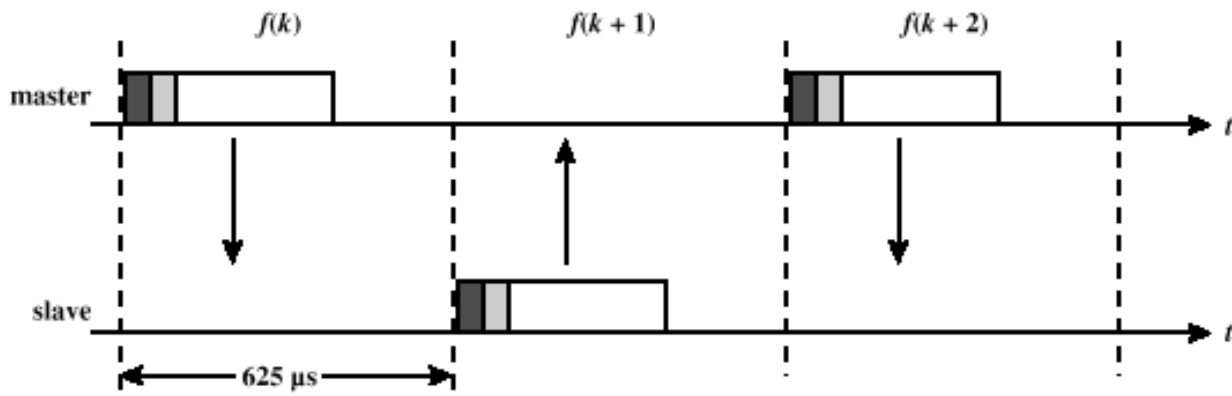

**Figure 15.6 Frequency-Hop Time-Division Duplex**

Physical Links between Master and Slave:

- Synchronous connection oriented (SCO)
  - Allocates fixed bandwidth between point-to-point connection of master and slave
  - Master maintains link using reserved slots
  - Master can support three simultaneous links
- Asynchronous connectionless (ACL)
  - Point-to-multipoint link between master and all slaves
  - Only single ACL link can exist

Bluetooth Packet Fields:

- Access code – used for timing synchronization, offset compensation, paging, and inquiry
- Header – used to identify packet type and carry protocol control information
- Payload – contains user voice or data and payload header, if present

Types of Access Codes:

- Channel access code (CAC) – identifies a piconet

- Device access code (DAC) – used for paging and subsequent responses
- Inquiry access code (IAC) – used for inquiry purposes

Access Code:

- Preamble – used for DC compensation
  - 0101 if LSB of sync word is 0
  - 1010 if LSB of synch word is 1
- Sync word – 64-bits, derived from:
  - 7-bit Barker sequence
  - Lower address part (LAP)
  - Pseudonoise (PN) sequence
- Trailer
  - 0101 if MSB of sync word is 1

1010 if MSB of sync word is 0

Packet Header Fields:

- AM\_ADDR – contains “active mode” address of one of the slaves
- Type – identifies type of packet
- Flow – 1-bit flow control
- ARQN – 1-bit acknowledgment
- SEQN – 1-bit sequential numbering schemes
- Header error control (HEC) – 8-bit error detection code

Payload Format:

- Payload header
  - L\_CH field – identifies logical channel
  - Flow field – used to control flow at L2CAP level
  - Length field – number of bytes of data
- Payload body – contains user data
- CRC – 16-bit CRC code

## Mobile IP and Wireless Application Protocol

- Enable computers to maintain Internet connectivity while moving from one Internet attachment point to another
- Mobile – user's point of attachment changes dynamically and all connections are automatically maintained despite the change
- Nomadic - user's Internet connection is terminated each time the user moves and a new connection is initiated when the user dials back in New, temporary IP address is assigned

### Operation of Mobile IP:

- Mobile node is assigned to a particular network – home network
- IP address on home network is static – home address
- Mobile node can move to another network – foreign network
- Mobile node registers with network node on foreign network – foreign agent
- Mobile node gives care-of address to agent on home network – home agent

### Capabilities of Mobile IP:

- Discovery – mobile node uses discovery procedure to identify prospective home and foreign agents
- Registration – mobile node uses an authenticated registration procedure to inform home agent of its care-of address
- Tunneling – used to forward IP datagrams from a home address to a care-of address

### Agent Solicitation:

- Foreign agents are expected to issue agent advertisement messages periodically
- If a mobile node needs agent information immediately, it can issue ICMP router solicitation message
- Any agent receiving this message will then issue an agent advertisement

### Move Detection:

- Mobile node may move from one network to another due to some handoff mechanism without IP level being aware
  - Agent discovery process is intended to enable the agent to detect such a move
- Algorithms to detect move:
  - Use of lifetime field – mobile node uses lifetime field as a timer for agent advertisements
  - Use of network prefix – mobile node checks if any newly received agent advertisement messages are on the same network as the node's current care-of address.
  -

### Co-Located Addresses:

- If mobile node moves to a network that has no foreign agents, or all foreign agents are busy, it can act as its own foreign agent
- Mobile agent uses co-located care-of address
  - IP address obtained by mobile node associated with mobile node's current network interface
- Means to acquire co-located address:

Temporary IP address through an Internet service, such as DHCP May be owned by the mobile node as a long-term address for use while visiting a given foreign network.

#### Registration Process:

- Mobile node sends registration request to foreign agent requesting forwarding service
- Foreign agent relays request to home agent
- Home agent accepts or denies request and sends registration reply to foreign agent
- Foreign agent relays reply to mobile node

#### Registration Operation Messages:

- Registration request message

Fields = type, S, B, D, M, V, G, lifetime, home address, home agent, care-of-address, identification, extensions

- Registration reply message

Fields = type, code, lifetime, home address, home agent, identification, extensions

#### Types of Authentication Extensions:

- Mobile-home – provides for authentication of registration messages between mobile node and home agent; must be present
- Mobile-foreign – may be present when a security association exists between mobile node and foreign agent
- Foreign-home – may be present when a security association exists between foreign agent and home agent

#### Tunneling:

- Home agent intercepts IP datagrams sent to mobile node's home address

Home agent informs other nodes on home network that datagrams to mobile node should be delivered to home agent

- Datagrams forwarded to care-of address via tunneling  
Datagram encapsulated in outer IP datagram

#### Wireless Application Protocol (WAP):

- Open standard providing mobile users of wireless terminals access to telephony and information services  
Wireless terminals include wireless phones, pagers and personal digital assistants (PDAs)  
Designed to work with all wireless network technologies such as GSM, CDMA, and TDMA  
Based on existing Internet standards such as IP, XML, HTML, and HTTP  
Includes security facilities



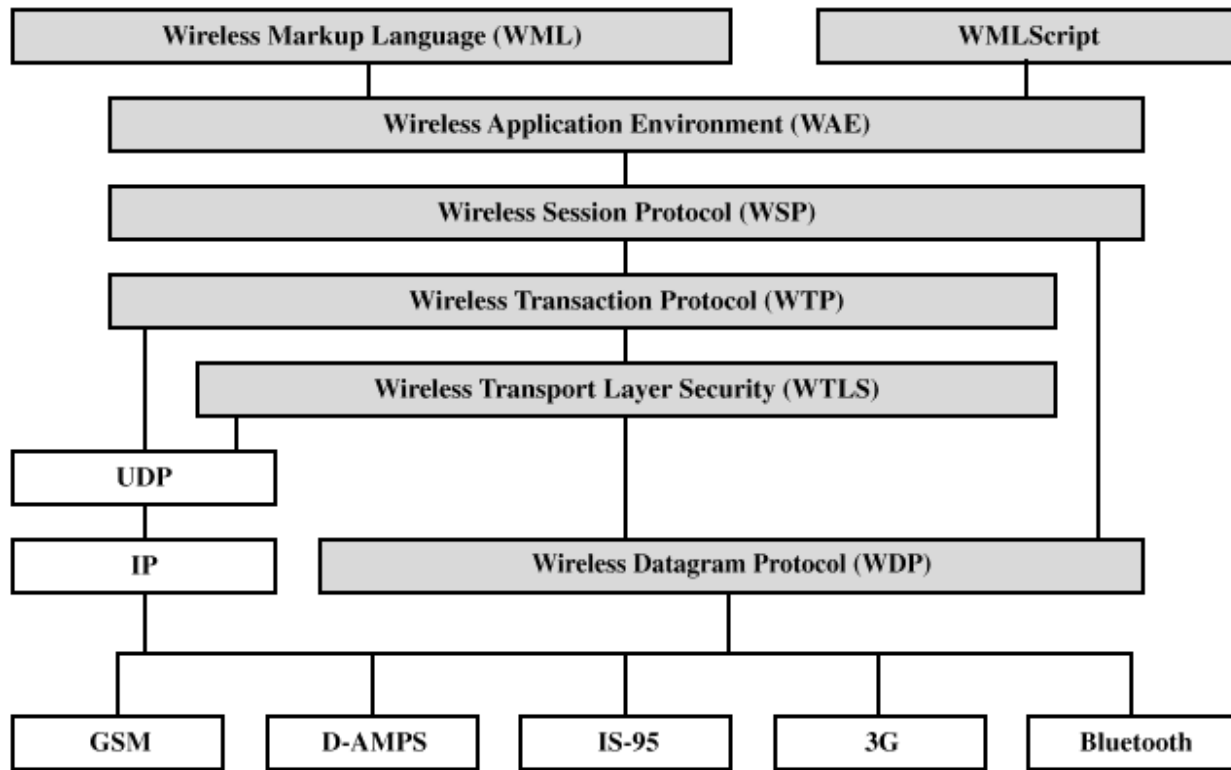

**Figure 12.8 WAP Protocol Stack**

WAP Programming Model:

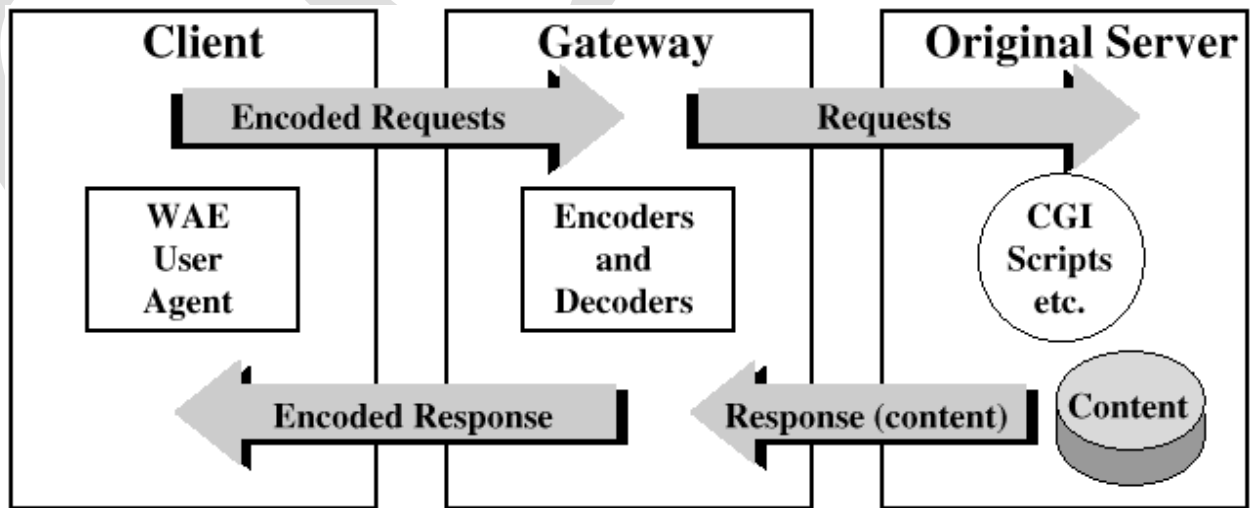

## Wireless Markup Language (WML) Features

- Text and image support – formatting and layout commands
- Deck/card organizational metaphor – WML documents subdivided into cards, which specify one or more units of interaction
- Support for navigation among cards and decks – includes provisions for event handling; used for navigation or executing scripts

## Wireless Application Environment (WAE):

- WAE specifies an application framework for wireless devices
- WAE elements:
  - WAE User agents – software that executes in the wireless device
  - Content generators – applications that produce standard content formats in response to requests from user agents in the mobile terminal
  - Standard content encoding – defined to allow a WAE user agent to navigate Web content
  - Wireless telephony applications (WTA) – collection of telephony-specific extensions for call and feature control mechanisms

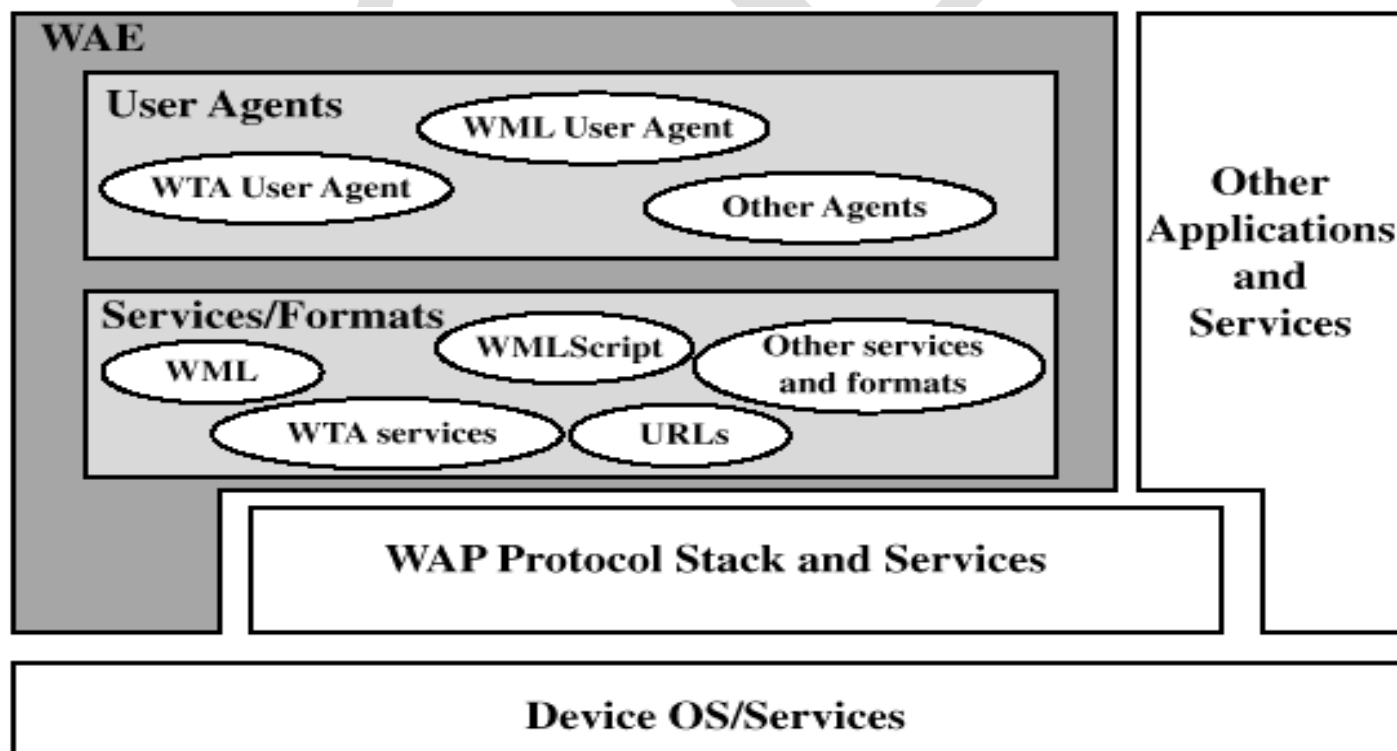

**Figure 12.11 WAE Client Components [WAPF98]**

## Cordless Systems and Wireless Local Loop:

### Cordless System Operating Environments:

- Residential – a single base station can provide in-house voice and data support
- Office
  - A single base station can support a small office
  - Multiple base stations in a cellular configuration can support a larger office
- Telepoint – a base station set up in a public place, such as an airport

### Design Considerations for Cordless Standards:

- Modest range of handset from base station, so low-power designs are used
- Inexpensive handset and base station, dictating simple technical approaches
- Frequency flexibility is limited, so the system needs to be able to seek a low-interference channel whenever used

### Time Division Duplex (TDD):

- TDD also known as time-compression multiplexing (TCM)
- Data transmitted in one direction at a time, with transmission between the two directions
  - Simple TDD
  - TDMA TDD

### Simple TDD:

- Bit stream is divided into equal segments, compressed in time to a higher transmission rate, and transmitted in bursts
- Effective bits transmitted per second:

$$R = B/2(T_p + T_b + T_g)$$

- $R$  = effective data rate
- $B$  = size of block in bits
- $T_p$  = propagation delay
- $T_b$  = burst transmission time

$T_g$  = guard time

## TDMA TDD:

- Wireless TDD typically used with TDMA
  - A number of users receive forward channel signals in turn and then transmit reverse channel signals in turn, all on same carrier frequency
- Advantages of TDMA/TDD:
  - Improved ability to cope with fast fading
  - Improved capacity allocation

## DECT Frame Format:

- Preamble (16 bits) – alert receiver
- Sync (16 bits) – enable receiver to synchronize on beginning of time slot
- A field (64 bits) – used for network control
- B field (320 bits) – contains user data
- X field (4 bits) – parity check bits
- Guard (60 bits) – guard time,  $T_g$

## Cellular Wireless Networks:

### Frequency Reuse:

- Adjacent cells assigned different frequencies to avoid interference or crosstalk
- Objective is to reuse frequency in nearby cells
  - 10 to 50 frequencies assigned to each cell
  - Transmission power controlled to limit power at that frequency escaping to adjacent cells
  - The issue is to determine how many cells must intervene between two cells using the same frequency

### Approaches to Cope with Increasing Capacity:

- Adding new channels
- Frequency borrowing – frequencies are taken from adjacent cells by congested cells
- Cell splitting – cells in areas of high usage can be split into smaller cells

- Cell sectoring – cells are divided into a number of wedge-shaped sectors, each with their own set of channels
- Microcells – antennas move to buildings, hills, and lamp posts

Steps in an MTSO Controlled Call between Mobile Users:

- Mobile unit initialization
- Mobile-originated call
- Paging
- Call accepted
- Ongoing call
- Handoff

Handoff Performance Metrics:

- Cell blocking probability – probability of a new call being blocked
- Call dropping probability – probability that a call is terminated due to a handoff
- Call completion probability – probability that an admitted call is not dropped before it terminates
- Probability of unsuccessful handoff – probability that a handoff is executed while the reception conditions are inadequate

## 16. University Question papers of previous years

### IV B.Tech II Semester Examinations, APRIL 2011 WIRELESS COMMUNICATIONS AND NETWORKS

Common to Electronics And Computer Engineering, Electronics And Telematics,  
Electronics And Communication Engineering

Time: 3 hours

Max Marks: 80

Answer any FIVE Questions  
All Questions carry equal marks

1. (a) Describe about short message servicing?  
(b) What is the number of bits in each burst of GPRS and how does it differ from a GSM burst? [8+8]
2. (a) Explain the quality of service (QoS) requirements for adhoc networks?  
(b) Name the four states that a Bluetooth terminal can take and explain the difference among these states? [8+8]
3. (a) What are the eleven commands offered by L2CAP?  
(b) Discuss the quality of service parameter in L2CAP. [8+8]
4. (a) Explain packet flow if two mobile nodes communicate and both are in foreign networks. What additional router do packets take if reverse tunneling is required?  
(b) What are the primary goals of the WAP forum efforts and how are they reflected in the WAP protocol architecture? [8+8]
5. (a) Draw the configuration of IEEE802.11 architecture?  
(b) Explain the physical layer specifications of IEEE802.11 using infrared? [8+8]
6. CSMA is a contention access protocol with partial co-ordination among multiple users. Explain why and how CSMA should provide better throughput performance than ALOHA systems. Plot the throughput curves and give your comments. [16]
7. (a) Explain about the public switched telephone network (PSTN).  
(b) Explain how a PBX may be used to provide telephone connections throughout a building. [8+8]
8. (a) Discuss the link layer characteristics of CDPD.  
(b) Explain the advanced radio information system (ARDIS). [8+8]

Code No: 07A80404

**R07**

**Set No. 4**

**IV B.Tech IISemester Examinations, APRIL'11 WIRELESS COMMUNICATIONS AND NETWORKS**

Common to Electronics And Computer Engineering,  
Electronics And Telematics, Electronics And  
Communication Engineering

Time: 3 hours

Answer any FIVE Questions  
All Questions carry equal marks

1. (a) Discuss about the security aspects in the Bluetooth.  
(b) What are the elements in the core protocols? [8+8]
2. (a) Distinguish between wireless and fixed telephone networks.  
(b) Mention the limitations of wireless networks. [8+8]
3. (a) Explain ATM virtual circuits with a neat figure.  
(b) Explain the functioning of OMAP (operation maintenance and administration part). [8+8]
4. (a) Mention the various multiple access techniques that are used in various wireless Communication systems.  
(b) Find the inter modulation frequencies generated if a base station transmits two carrier frequencies at 1930 MHz and 1932 MHz that are amplified by a saturated clipping amplifier. If the mobile band is allocated from 1920 MHz to 1940 MHz designate the IM frequencies that lie inside and outside the band. [8+8]
5. (a) Discuss about type1 operation of logical link control?  
(b) Write the differences between HDLC and logical link control? [8+8]
6. (a) Explain the nature of the interference between the Bluetooth and IEEE 802.11b? (b) What is the difference between a logical and a transport channel in HIPER-LAN2? [8+8]
7. (a) Explain about forward channel and reverse channel in CDPD physical layer? (b) What are the new elements added to the AMPS infrastructure to support CDPD? [8+8]
1. (a) In an typical mobile IP implementation in a home agent, the agent maintains a mobility binding table to map a mobile nodes home

Code No: 07A80404

R07

Set No. 4

address to its care of address for packet forwarding. What entries are essential for each row of the table?

- (b) In WTLS, why is there a separate change cipher spec protocol, rather than including a change - cipher - spec message in the hand shake protocol.

[8+8]

ACCEPT



**IV B.Tech II Semester Examinations, APRIL 2011**  
**WIRELESS COMMUNICATIONS AND NETWORKS**

Common to Electronics And Computer Engineering, Electronics And Telematics, Electronics And Communication Engineering

Time: 3 hours

Max Marks: 80

Answer any FIVE Questions  
All Questions carry equal marks

1. (a) What are the constraints on cellular networks to provide internet based mobile applications?  
(b) Explain the Handoff procedure in CDPD with neat diagram? [8+8]
2. (a) List the international frequency allocations for Bluetooth.  
(b) Discuss about the adhoc systems. [8+8]
3. (a) Explain the functions of SS 7 user part.  
(b) Discuss the various services provided by SS 7. [8+8]
4. (a) What is the principal application that has driven the design of circuit switching network.  
(b) Distinguish between static and alternate routing in a circuit switching Network. [8+8]
5. Differentiate between distributed access protocols and centralized access protocols at MAC layer? [16]
6. (a) Discuss the cell capacity of TDMA system.  
(b) Compare the multiple access techniques in terms of modulation, FEC coding, diversity, system complexity and multiple access interference (MAI). [8+8]
7. (a) What problems of HTTP can WSP solve? Explain why these solutions are needed in wireless mobile environment.  
(b) What advantages does a connectionless session service offer compared to a simple datagram service? [8+8]
8. (a) Draw the block diagram of OFDM modem and explain functionality of each block?  
(b) Explain the differences between the medium access control mechanisms of the HIPERLAN2 and IEEE802.11? [8+8]

## 17. Question Bank:

### UNIT 1

1. If a normal GSM time slot consists of six training bits, 8.25 guard bits, 26 training bits and two traffic bursts of 58 bits of data, find the frame efficiency.
2. In a CDMA system, the required  $E_b/N_o$  is 7 dB and the processing gain is 22dB. Find the number of available users, assuming that there is no forward power control.
3. Explain Frequency hopped multiple Access (FHMA)
4. What is meant by near-far effect in CDMA and explain how this effect is eliminated?
5. In an slotted ALOHA system, the packet arrival times form a Poisson process having a rate of  $10^3$  packets/sec. if the bit rate is 10 Mbps and there 1000 bits/Package find.
  - I) The normalized throughput of the system and
  - II) The number of bits per packet that will maximize the throughput.
6. Explain the following,
  - I) Non persistent CSMA
  - II) 1-Persistent CSMA
7. Explain the PRMA (packet reservation Multiple Access)
8. Explain the CDPA (CAPTURE DIVISION PACKET ACCESS)

### UNIT 2

1. Explain the
  - a) Autonomus registration.
  - b) Interoperated roaming.In the 1<sup>st</sup> generation Cellular Systems.
2. Discuss the traffic routing in wireless networks.
3. Distinguish between connection oriented services and connectionless services .

OR

Explain the difference between data gram and virtual circuit operation.

4. Explain the following,
  - I) Circuit Switching

II) Packet switching.

5. Discuss the packet data format in packet switching.

6. Mention the advantages of packet switching approach over circuit switching.

### **UNIT 3.**

1. Draw the block schematic of CDPD network and explain its functioning?

2. Write short notes on “cellular digital packet data(CDPD)”

3. Explain the following signaling in ISDN with a neat block diagram

I) Access signaling

II) Network signaling

4 Explain the types of bearer services in ISDN in terms of speed of transmission, type of channel, type of service.

### **UNIT 4:**

1. If local anchor is technique used to reduce registration cost, how to choose the local anchor as the mobile migrates from one foreign network to another.
2. List the entries of mobile IP and describe data transfer from a mobile node to a fixed node and vice versa.
3. Compare the advantages and disadvantages of two routing schemes in mobile IP.
4. What problems of HTTP can WSP solve? Explain why these solutions are needed in wireless mobile environment?

### **UNIT 5:**

1. Discuss three transmission techniques used for IR data transmission.
2. What are the strengths and drawbacks of Infrared wireless LANs?
3. List and briefly explain the IEEE.802 protocol layers?
4. What is the difference between MAC address and an LLC address?
5. What is the difference between access point and a portal?

### **UNIT 6:**

1. List the Bluetooth radio and baseband parameters?
2. Explain the two major states in establishing a link for piconets?
3. Explain the paging procedure in piconets?
4. How synchronization of clocks is provided in link manager protocol of Bluetooth?
5. How synchronization of clocks is provided in link manager protocol of Bluetooth?

#### **UNIT 7:**

1. What are the new elements added to the AMPS infrastructure to support CDPD?
2. Explain about forward channel and reverse channel in CDPD physical layer.
3. Discuss about location management in GPRS?
4. Draw the protocol stack for GPRS and discuss it?
5. Draw the wireless Application protocol (WAP) layered protocol architecture?

#### **UNIT 8:**

1. Explain one routing protocol in adhoc networking?
2. How many different voice services does Bluetooth support and how they are different from one another?
3. Explain the adhoc network architecture in HIPERLAN1?
4. Discuss the applications supported by IEEE 802.15 home RF technology?
5. Explain one routing protocol in adhoc networking?

## **18. Assignment topics:**

### **UNIT I:**

1. Paging systems
2. Cordless telephone systems, compression of various wireless systems.

### **UNIT II: Assignment Topics**

1. Types of wireless LAN
2. Traffic routing in wireless Networks
3. X.25 protocol

### **UNIT III:**

1. Basic cellular system
2. Channel assignment strategies
3. Handoff strategies
4. Improving coverage and capacity, cell splitting.

### **UNIT IV:**

1. Operation of mobile IP
2. WAP
3. WTP
4. WDP

### **UNIT V:**

1. Difference between wireless and fixed telephone networks
2. Development of wireless networks,
3. Fixed network transmission hierarchy, traffic routing in wireless

### **UNIT VI:**

1. Applications of Bluetooth
2. Logical Link control
3. L2 CAP

### **UNIT VII:**

1. Wireless home networking IEEE 802.11 the PHY layer
2. MAC layer wireless ATM
3. Hyperlink, Hyper Lan-2

**UNIT VIII:**

1. WATM
2. HIPERLAN
3. Ad Hoc networking and WPAN

**20. Unit wise Quiz Questions and long answer questions:**

GCEET

## Multiple-choice questions(UNIT3)

1. Wireless LANs will operate in which one of the following configurations?
  - a. With base stations only
  - b. Without base stations only
  - c. Either a or b
  - d. None of the above
  
2. Which one of the following is the main standard for WLANs?
  - a. IEEE 802.15
  - b. IEEE 802.3
  - c. IEEE 802.11
  - d. IEEE 802.16
  
3. In the above figure, which one of the following gives the hidden station problem?
  - a. When both B and C wants to transmit to station D
  - b. When only B wants to transmit to A
  - c. When C wants to transmit to both B and D
  - d. When A and C wants to transmit to B
  
4. In the same figure, which one of the following gives the exposed station problem?
  - a. A and C want to transmit to B
  - b. A is sending to some other station E and B wants to send to C
  - c. Only B wants to transmit to A
  - d. Both B and C wants to transmit to station D
  
5. Which one of the following is to be considered in WLANs?
  - a. Multipath fading
  - b. Handoff
  - c. Mobility awareness
  - d. All the above
  
6. NAV packets are transmitted by which one of the following stations in DCF?
  - a. The station that wants to transmit data
  - b. The station willing to receive data
  - c. All the stations other than sender and receiver (virtually)

d. There is nothing called NAV in DCF

7. In the 802.11 frame structure, subtype field is used for which one of the following?

- a. To differentiate control and data frames
- b. Used by the base station to send receiver into sleep
- c. To tell receiver this is the last frame
- d. None of the above

8. Which one of the following is the main standard for Bluetooth?

- a. IEEE 802.15
- b. IEEE 802.3
- c. IEEE 802.11
- d. IEEE 802.16

9. Which one of the following gives the number of nodes in a Scatternet?

- a. One
- b. None
- c. At least two
- d. None of the above

10. The Bluetooth baseband layer is responsible for which one of the following?

- a. Defining transmission characteristics
- b. Communicating with its peer in the target device
- c. Sending authentication information
- d. Establishing links with other Bluetooth devices

#### **Multiple-choice questions(UNIT4)**

1. Which one of the following is called a “process”?

- a. Program in execution
- b. Code
- c. State specific to underlying operating system
- d. Object

2. Which one of the following is not a component of the system process’s kernel in a distributed operating system?



- a. Command interpreter
- b. Process manager
- c. Memory scheduler
- d. File manager

3. Which one of the following is an instance of a migrated process?

- a. Destination instance
- b. Remote instance
- c. Correspondent instance
- d. Source instance

4. Which one of the following is not a step in process migration?

- a. Process is detached from its source node
- b. State is transferred and imported into a new instance on the remote node
- c. Migration request is issued to a source node
- d. Destination process instance is created

5. Which one of the following is an advantage of process migration?

- a. Fault resilience
- b. Data sharing
- c. Memory sharing
- d. Improved resource administration

6. Which one of following is not an application of process migration?

- a. Parallelizable application
- b. Resource sharing application
- c. Migration-aware application
- d. Network and mobile computing application

7. Which one of the following is an alternative to process migration?

- a. Generic multiuser workloads
- b. Migration-aware applications
- c. Remote execution
- d. Object migration at the top level

8. Which one of the following does a thread consist of?

- a. Process's address space
- b. Own address space
- c. Own data space
- d. Own signals

9. Which one of the following is meant by a process?

- a. Program in waiting state
- b. Process is passive entity
- c. Program in execution
- d. Program in suspended state

10. Which one of the following is not included in the transferred state of a migrated process?

- a. Process's address space
- b. Signals
- c. Execution point
- d. Communication state

#### Multiple-choice questions (UNIT4)

1. Which one of the following is the mobility requirement for physical mobility?

- a. Low power
- b. Low bandwidth
- c. Small user interface
- d. Address migration

2. Which of following is the problem associated with the portability requirement for physical mobility?

- a. Low power
- b. Risk to data
- c. Small user interface
- d. All of the above

3. Which of the following subsystems consume the highest amount of power in a portable computer?

- a. Display edge light
- b. Keyboard
- c. Hard disk

d. Display

4. Which one of the following is the problem in IPv4 addressing for physical mobility?
- a. It has 32-bit addresses
  - b. It does not provide quality-of-service support
  - c. Its routing and forwarding requires a fixed IP determined by network
  - d. It has security issues
5. The mobility binding table in mobile IP is maintained by
- a. Mobile node
  - b. Home agent
  - c. Foreign agent
  - d. All of the above
6. Which one of the following is one of the columns of the visitor list maintained by the foreign agent?
- a. Home address
  - b. Media address
  - c. Life time
  - d. All of the above
7. Why is mobile IP not suitable for seamless mobility?
- a. Route optimization is optional in mobile IP
  - b. After each migration, local address must to obtained and communicated to home agent
  - c. Mobile IP requires home and foreign agents
  - d. All of the above
8. What is the major difference between the routing and paging caches in cellular IP?
- a. Paging cache is used to find an idle mobile if a packet is to be sent there, but there is no entry in routing cache.
  - b. Paging cache is related to mobile IP while routing cache is to cellular IP.
  - c. The timeout interval of routing cache is larger than that of the paging cache.
  - d. None of the above
9. Venus acts as psuedoserver in which of the following states in CODA?
- a. Hoarding
  - b. Reintegration
  - c. Emulation

d. None of the above

10. Which of the following is NOT one of the main design rationales for CODA?

- a. Preserving transparency
- b. Scalability
- c. Consistency
- d. Low power

### Multiple-choice questions (UNIT5)

1. The destination-sequenced distance vector (DSDV) protocol can be viewed as which one of the following?

- a. Reactive routing protocol
- b. Proactive routing protocol
- c. Hybrid routing protocol
- d. Multicast routing protocol

2. Which one of the following is a type of MANET?

- a. Personal area network
- b. Body area network
- c. Wireless LAN
- d. All of the above

3. Which of the following is NOT true with respect to a MANET?

- a. All the nodes in a MANET are free to move arbitrarily
- b. Power consumption is a major issue in MANETs.
- c. MANETs offer less mobility as compared to 802.11 Wi-Fi.
- d. MANETs are more vulnerable to security threats than wired or 802.11 Wi-Fi networks.

4. Which one of the following is the memory requirement of destination-sequenced distance vector (DSDV) protocol?

- a.  $O(n)$
- b.  $O(n \log n)$
- c.  $O(1)$
- d.  $O(n^2)$

5. Which of the following is a reactive routing protocol for MANETs?
- CSMA/CA
  - Dynamic source routing (DSR)
  - Link state routing protocol
  - DSDV
6. In the dynamic source routing (DSR) protocol, a route error (RERR) packet is sent during which of the following?
- Route discovery
  - Route maintenance
  - Both of these
  - None of these
7. The major contribution to routing overhead in AODV comes from
- RERR packets
  - RREP packets
  - RREQ packets
  - None of these
8. Which of the following fields is contained in the route request (RREQ) packet?
- Destination IP address
  - Request ID
  - Source sequence number
  - All of the above
9. Which of the following is the correct order for the communicating range of the three types of networks?
- PAN>WLAN>BAN
  - WLAN>BAN>PAN
  - WLAN>PAN>BAN
  - BAN>WLAN>PAN
10. Which one of the following statements is FALSE?
- AODV uses table-driven routing
  - AODV outperforms DSR in highly mobile environments
  - DSR has access to greater amount of routing information than AODV
  - In DSR, the destination replies only once to the request arriving first and ignores multiple

requests

### Multiple-choice questions (UNIT6)

1. Smart dust is a synonym for which of the following?
  - a. Wireless sensor networks
  - b. Mobile ad hoc networks
  - c. Wearable computers
  - d. Both (a) and (c)
  
2. The kind of computing where computers become so small and so omnipresent that they fade into the background is known as
  - a. Soft computing
  - b. Pervasive computing
  - c. Hard computing
  - d. None of the above
  
3. Which one of the following is true for the statements X and Y?

X: Sensor nodes mainly use the broadcast communication paradigm

Y: Most ad hoc networks are based on point-to-point communication

  - a. X is true but Y is false
  - b. X is false but Y is true
  - c. Both X and Y are true
  - d. Both X and Y are false
  
4. Which of the following layers is not present in WSN (wireless sensor network) communications architecture?
  - a. Physical layer
  - b. Data link layer
  - c. Presentation layer
  - d. Application layer

5. Which one of the following balances and schedules the sensing tasks given to a specific region?
- Power management plane
  - Task management plane
  - Mobility management plane
  - Balance management plan
6. Which of the following protocols are query-based and depend on the naming of desired data, which helps in eliminating many redundant transmissions?
- Data-centric protocols
  - Hierarchical protocols
  - Location-based protocols
  - None of the above
7. A process where the receiving node sends the packet to a randomly selected neighbour, which picks another random neighbour to forward the packet to, and so on is known as
- Flooding
  - SPIN
  - LEACH
  - Gossiping
8. Which one of the following algorithms avoids the problem of implosion by just selecting a random node to send the packet rather than broadcasting?
- Flooding
  - LEACH
  - Gossiping
  - SPIN
9. Which one of the following is a hierarchical protocol designed to respond to sudden changes in the sensed attributes, such as temperature?
- LEACH
  - PEGASIS
  - TEEN
  - Gossiping
10. The TinyOS system, libraries and applications are written in which one of the following languages?
- NesC
  - C++

- c. Java
- d. C

### Multiple-choice questions (UNIT6)

1. Which one of the following vendors is considered the most secure?
  - a. Palm
  - b. BlackBerry
  - c. Windows Pocket PC
  - d. Handspring Visor family
  
2. How much memory of Palm Zire 71 is user accessible?
  - a. 16 MB
  - b. 12 MB
  - c. 14 MB
  - d. 20 MB
  
3. Which of the following wireless communication techniques is used in personal area networks?
  - a. Wi-Fi 802.11b
  - b. CDMA
  - c. Bluetooth
  - d. AT&T Wireless
  
4. In which state is the Windows CE device not powered, so that all volatile RAM data and code are lost?
  - a. Suspended
  - b. Dead
  - c. Blocked
  - d. Terminated
  
5. Which one of the following companies manufactured Palm OS-based devices?
  - a. Kyocera
  - b. Sun Microsystems
  - c. Apple
  - d. HP



6. Which one of the following operating systems supports multithreading and multitasking?
- a. Palm OS
  - b. Windows CE
  - c. Symbian
  - d. None of the above
7. A record database can be used to store which one of the following?
- a. Unordered list of records
  - b. Ordered list of records
  - c. Application codes
  - d. None of the above
8. Which of the following is the memory capacity of Palm m515?
- a. 16 MB
  - b. 24 MB
  - c. 8 MB
  - d. 20 MB
9. Which one of the following vendors is heavily depended on the third-party software?
- a. Windows Pocket PC
  - b. BlackBerry
  - c. Palm
  - d. None of the above
10. What is the latest version of Palm handheld devices?
- a. Palm m215
  - b. Palm i705
  - c. Palm IIIx
  - d. Palm Zire

**Multiple-choice questions (UNIT7)**

1. Which one of the following does WAP stand for?
- Wireless access protocol
  - Web access protocol
  - Web application protocol

Wireless application protocol

2. Which one of the following is not a WAP programming model component?
- WAP microbrowser
  - HTTP server
  - Push indicator
  - Pop indicator
3. Which one of the following are the enhancements that WAP has added to the Web programming model?
- Push and telephony.
  - Pop and telephony.
  - Telephony support only
  - Pop only
4. WTP stands for which one of the following?
- Wireless transport protocol
  - Wireless transaction protocol
  - Wired transaction protocol
  - None of the above
5. Which one of the following features does not belong to WAP 2.0?
- Pop
  - Push as well as pop
  - Multimedia messaging
  - Interfaces to storage devices
6. Which one of the following changes to TCP is incorporated in WAP 2.0?
- Window size variable
  - Window size is fixed of size 64 KB
  - No slow start
  - Window size is fixed at 64 KB and no slow start
7. WAP 2.0 runs at which one of the following speeds?
- 364 Kbps
  - 384 Kbps
  - 54 Mbps

11 Mbps

8. Which one of the following features is provided by the WAP gateway?

- Simple gateway functionalities
- Simple gateway functionalities plus push operation
- Simple gateway functionalities plus on-the-fly image conversion
- All of the above

9. Which one of the following are WAP gateway components?

- Encoder only
- Decoder only
- Encoder, decoder and protocol conversion
- Encoder, decoder, protocol conversion and WAP protocol stack

10. Push architecture consists of which one of the following?

- Push indicator and WAP gateway
- Push locator and WAP gateway
- WAP gateway and push initiator
- None of the above

### Multiple-choice questions (UNIT8)

1. An agent is said to be reactive by which one of the following properties?

- a. Ability to respond to incoming messages
- b. Runs in its own thread of execution
- c. Autonomous
- d. Has inherent navigational autonomy

2. Which one of the following is not considered as a requirement for mobile agent systems?

- a. Portability
- b. Security
- c. Ubiquity
- d. Resource availability

3. Which one of the following features of Java enables agent interaction?
- Synchronization
  - Reflection
  - Multithreading
  - Object serialization
4. The agent\_accept command in Agent\_Tcl is used for which one of the following functions?
- Initiate a communication
  - Synchronize the two agents
  - Start agent execution on remote machine
  - Negotiate agent exchange
5. Which one of the following is considered as an end point of an incremental evolution of mobile abstractions?
- Mobile code
  - Mobile agent
  - Mobile process
  - Mobile object
6. Agent-agent communication allows an agent to do which one of the following actions?
- Transfer it to another host
  - Communicate with other agent
  - Bring it from another host
  - Determine what messages it accepts
7. Which one of the following does an itinerary not provide to a mobile agent?
- Convenient abstraction for non-trivial patterns and routing
  - A travel plan
  - Parallel processing by cloning
  - Message sending to other agent
8. Aglet programming model is considered to be which one of the following?
- Event-based
  - Process-based
  - Object-based
  - Thread-based

9. Agent Tcl uses pretty good privacy (PGP) for which one of the following functions?
- To encrypt servers
  - To authenticate servers
  - To authorize servers
  - None of the above
10. Which one of the following does the agent level support system in Agent Tcl provide?
- Navigation of agents between remote systems
  - High-level communication mechanism
  - Provides a resource management
  - All of the above

**Code No: 05420401 Set No. 1**

**JAWAHARLAL NEHRU TECHNOLOGICAL UNIVERSITY HYDERABAD**

**IV B.Tech. II Sem., I Mid-Term Examinations, March– 2010**

**WIRELESS COMMUNICATIONS AND NETWORKS**

**Objective Exam**

**Name: \_\_\_\_\_ Hall Ticket No. \_\_\_\_\_**

**Answer All Questions. All Questions Carry Equal Marks. Time: 20 Min. Marks: 20.**

**I Choose the correct alternative:**

- Bandwidth of FDMA channels in Advanced Mobile phone system is [ ]  
A) 80 MHz B) 30 MHz C) 30 KHz D) None
- The band that provides traffic from the mobile to the base station is called [ ]  
A) Forward band B) Reverse band C) Dual band D) None
- The Protocol that connects mobile subscribers to the base station is [ ]  
A) Local exchange carrier B) Common Air Interface  
C) Local Access and transport D) None.
- Sequence control and error detection in CDPD is provided by \_\_\_ Protocol. [ ]  
A) MDLP B) MDDBS C) RMD D) None
- Spectrum efficiency of RD – LAP (Radio Data link Access procedure) protocol used by ARDISis [ ]  
A) 0.19 B) 0.25 C) 0.77 D) None.
- The protocol that is widely used for common channel signaling between inter connected networks is \_\_\_\_\_ - [ ]  
A) SS7 B) ATM C) isdn D) None.

7. Common channel signaling (CCS) system uses \_\_\_\_\_ technique to provide communication between two nodes. [ ]  
A) ARDIS B) Out of band signaling C) Narrow band D) None.
8. In WAP \_\_\_\_\_ protocol supports a client to send multiple requests to a server simultaneously [ ]  
A) WSP B) WDP C) WTP D) None.
9. Different encryption mechanisms with different key length in WAP are provided by \_\_\_\_\_ [ ]  
A) WDP B) WSP C) WTLS D) None.
10. The size of a cell in Asynchronous transfer mode (ATM) is \_\_\_\_\_ bytes. [ ]  
A) 48 B) 53 C) 5 D) None.

**Code No: 05420401 -2- Set No. 1**

**II. Fill in the blanks:**

11. Spectral efficiency of packet radio multiple access is \_\_\_\_\_
12. \_\_\_\_\_ Problem occurs when multiple or many mobile users share the same channel in CDMA.
13. Cellular Digital packet Data transfers the data with a data rate of \_\_\_\_\_ bps.
14. Routing overhead is more in \_\_\_\_\_ routing.
15. RAM Mobile Data (RMD) service developed by Eriksson is based on \_\_\_\_\_ protocol
16. Primary rate interface (PRI) in ISDN provides \_\_\_\_\_ number of bearer channels
17. Services of SSCP and MTP in SS7 are invoked by \_\_\_\_\_
18. \_\_\_\_\_ operations are performed by mobile IP protocol while transferring a packet from one protocol layer to other.
19. The source and destination port numbers offered by wireless datagram protocol (WDP) are used for \_\_\_\_\_
20. Pushing and pulling of data transfer in WAP is accomplished through \_\_\_\_\_ protocol.

**-oOo-**

**Code No: 05420401 Set No. 2**

**JAWAHARLAL NEHRU TECHNOLOGICAL UNIVERSITY HYDERABAD**

**IV B.Tech. II Sem., I Mid-Term Examinations, March– 2010**

**WIRELESS COMMUNICATIONS AND NETWORKS**

**Objective Exam**

**Name: \_\_\_\_\_ Hall Ticket No.**

**Answer All Questions. All Questions Carry Equal Marks. Time: 20 Min. Marks: 20.**

**I Choose the correct alternative:**

Dept. of Electronics and Communication Engineering

1. Sequence control and error detection in CDPD is provided by \_\_\_ Protocol. [ ]  
A) MDLP B) MDBS C) RMD D) None
2. Spectrum efficiency of RD – LAP (Radio Data link Access procedure) protocol used by ARDIS is [ ]  
A) 0.19 B) 0.25 C) 0.77 D) None.
3. The protocol that is widely used for common channel signaling between inter connected networks is \_\_\_\_\_ - [ ]  
A) SS7 B) ATM C) isdn D) None.
4. Common channel signaling (CCS) system uses \_\_\_\_\_ technique to provide communication between two nodes. [ ]  
A) ARDIS B) Out of band signaling C) Narrow band D) None.
5. In WAP \_\_\_\_\_ protocol supports a client to send multiple requests to a server simultaneously [ ]  
A) WSP B) WDP C) WTP D) None.
6. Different encryption mechanisms with different key length in WAP are provided by \_\_\_\_\_ [ ]  
A) WDP B) WSP C) WTLS D) None.
7. The size of a cell in Asynchronous transfer mode (ATM) is \_\_\_ bytes. [ ]  
A) 48 B) 53 C) 5 D) None.
8. Bandwidth of FDMA channels in Advanced Mobile phone system is [ ]  
A) 80 MHz B) 30 MHz C) 30 KHz D) None
9. The band that provides traffic from the mobile to the base station is called [ ]  
A) Forward band B) Reverse band C) Dual band D) None
10. The Protocol that connects mobile subscribers to the base station is [ ]  
A) Local exchange carrier B) Common Air Interface  
C) Local Access and transport D) None.

**Code No: 05420401 -2- Set No. 2**

**II. Fill in the blanks:**

11. Routing overhead is more in \_\_\_\_\_ routing.
12. RAM Mobile Data (RMD) service developed by Eriksson is based on \_\_\_\_\_ protocol
13. Primary rate interface (PRI) in ISDN provides \_\_\_\_\_ number of bearer channels
14. Services of SSCP and MTP in SS7 are invoked by \_\_\_\_\_
15. \_\_\_\_\_ operations are performed by mobile IP protocol while transferring a packet from one protocol layer to other.
16. The source and destination port numbers offered by wireless datagram protocol (WDP) are used for \_\_\_\_\_
17. Pushing and pulling of data transfer in WAP is accomplished through \_\_\_\_\_ protocol.
18. Spectral efficiency of packet radio multiple access is \_\_\_\_\_

19. \_\_\_\_\_ Problem occurs when multiple or many mobile users share the same channel in CDMA.
20. Cellular Digital packet Data transfers the data with a data rate of \_\_\_\_ bps.

GCEET



**Code No: 05420401 Set No. 3**

**JAWAHARLAL NEHRU TECHNOLOGICAL UNIVERSITY HYDERABAD**

**IV B.Tech. II Sem., I Mid-Term Examinations, March– 2010**

**WIRELESS COMMUNICATIONS AND NETWORKS**

**Objective Exam**

**Name: \_\_\_\_\_ Hall Ticket No.**

**Answer All Questions. All Questions Carry Equal Marks. Time: 20 Min. Marks: 20.**

**I Choose the correct alternative:**

1. The protocol that is widely used for common channel signaling between inter connected networks is \_\_\_\_\_ - [ ]  
A) SS7 B) ATM C) isdn D) None.
2. Common channel signaling (CCS) system uses \_\_\_\_\_ technique to provide communication between two nodes. [ ]  
A) ARDIS B) Out of band signaling C) Narrow band D) None.
3. In WAP \_\_\_\_\_ protocol supports a client to send multiple requests to a server simultaneously [ ]  
A) WSP B) WDP C) WTP D) None.
4. Different encryption mechanisms with different key length in WAP are provided by [ ]  
A) WDP B) WSP C) WTLS D) None.
5. The size of a cell in Asynchronous transfer mode (ATM) is \_\_\_\_\_ bytes. [ ]  
A) 48 B) 53 C) 5 D) None.
6. Bandwidth of FDMA channels in Advanced Mobile phone system is [ ]  
A) 80 MHz B) 30 MHz C) 30 KHz D) None
7. The band that provides traffic from the mobile to the base station is called [ ]  
A) Forward band B) Reverse band C) Dual band D) None
8. The Protocol that connects mobile subscribers to the base station is [ ]  
A) Local exchange carrier B) Common Air Interface  
C) Local Access and transport D) None.
9. Sequence control and error detection in CDPD is provided by \_\_\_\_\_ Protocol. [ ]  
A) MDLP B) MDBS C) RMD D) None
10. Spectrum efficiency of RD – LAP (Radio Data link Access procedure) protocol used by ARDIS is [ ]  
A) 0.19 B) 0.25 C) 0.77 D) None.

**II. Fill in the blanks:**

11. Primary rate interface (PRI) in ISDN provides \_\_\_\_\_ number of bearer channels
12. Services of SSCP and MTP in SS7 are invoked by \_\_\_\_\_
13. \_\_\_\_\_ operations are performed by mobile IP protocol while transferring a packet from one protocol layer to other.
14. The source and destination port numbers offered by wireless datagram protocol (WDP) are used for \_\_\_\_\_

15. Pushing and pulling of data transfer in WAP is accomplished through \_\_\_\_\_ protocol.
16. Spectral efficiency of packet radio multiple access is \_\_\_\_\_
17. \_\_\_\_\_ Problem occurs when multiple or many mobile users share the same channel in CDMA.
18. Cellular Digital packet Data transfers the data with a data rate of \_\_\_\_\_ bps.
19. Routing overhead is more in \_\_\_\_\_ routing.
20. RAM Mobile Data (RMD) service developed by Eriksson is based on \_\_\_\_\_ protocol.

**Code No: 05420401 Set No. 4**

**JAWAHARLAL NEHRU TECHNOLOGICAL UNIVERSITY HYDERABAD**

**IV B.Tech. II Sem., I Mid-Term Examinations, March– 2010**

**WIRELESS COMMUNICATIONS AND NETWORKS**

**Objective Exam**

**Name: \_\_\_\_\_ Hall Ticket No. \_\_\_\_\_**

**Answer All Questions. All Questions Carry Equal Marks. Time: 20 Min. Marks: 20.**

**I Choose the correct alternative:**

1. In WAP \_\_\_\_\_ protocol supports a client to send multiple requests to a server simultaneously [ ]  
A) WSP B) WDP C) WTP D) None.
2. Different encryption mechanisms with different key length in WAP are provided by \_\_\_\_\_ [ ]  
A) WDP B) WSP C) WTLS D) None.
3. The size of a cell in Asynchronous transfer mode (ATM) is \_\_\_\_\_ bytes. [ ]  
A) 48 B) 53 C) 5 D) None.
4. Bandwidth of FDMA channels in Advanced Mobile phone system is [ ]  
A) 80 MHz B) 30 MHz C) 30 KHz D) None
5. The band that provides traffic from the mobile to the base station is called [ ]  
A) Forward band B) Reverse band C) Dual band D) None
6. The Protocol that connects mobile subscribers to the base station is [ ]  
A) Local exchange carrier B) Common Air Interface  
C) Local Access and transport D) None.
7. Sequence control and error detection in CDPD is provided by \_\_\_\_\_ Protocol. [ ]  
A) MDLP B) MDBS C) RMD D) None
8. Spectrum efficiency of RD – LAP (Radio Data link Access procedure) protocol used by ARDIS is [ ]  
A) 0.19 B) 0.25 C) 0.77 D) None.
9. The protocol that is widely used for common channel signaling between inter connected networks is \_\_\_\_\_ - [ ]  
A) SS7 B) ATM C) isdn D) None.
10. Common channel signaling (CCS) system uses \_\_\_\_\_ technique to provide communication between two nodes. [ ]

A) ARDIS B) Out of band signaling C) Narrow band D) None.

GCEET

**Code No: 05420401 -2- Set No. 4**

**II. Fill in the blanks:**

11. \_\_\_\_\_ operations are performed by mobile IP protocol while transferring a packet from one protocol layer to other.
12. The source and destination port numbers offered by wireless datagram protocol (WDP) are used for \_\_\_\_\_
13. Pushing and pulling of data transfer in WAP is accomplished through \_\_\_\_\_ protocol.
14. Spectral efficiency of packet radio multiple access is \_\_\_\_\_
15. \_\_\_\_\_ Problem occurs when multiple or many mobile users share the same channel in CDMA.
16. Cellular Digital packet Data transfers the data with a data rate of \_\_\_\_\_ bps.
17. Routing overhead is more in \_\_\_\_\_ routing.
18. RAM Mobile Data (RMD) service developed by Eriksson is based on \_\_\_\_\_ protocol
19. Primary rate interface (PRI) in ISDN provides \_\_\_\_\_ number of bearer channels
20. Services of SSCP and MTP in SS7 are invoked by \_\_\_\_\_

**21. Tutorial problems/topics:**

**Unit I:**

- Numerical on FDMA and TDMA
- Packet radio
- CSMA
- PRMA & CDPA

**Unit II:**

- WPANs
- Limitations of wireless networking
- Network subsystem
- X.25 protocol

**Unit III:**

- BISDN
- ATMNSP of SS7
- SS7 user part

**Unit IV:**

- IP packet delivery
- Registrations
- Tunneling Features of WAP

**Unit V:**

- Spread spectrum LANs
- MAC
- LLC services

**Unit VI:**

- L2 CAP
- WLL technology
- MMDS
- LMDS

**Unit VII:**

- GPRS architecture
- GPRS support mobility
- Mobile application protocol

**Unit VIII:**

- Wireless ATM
- Architecture Of HIPERLAN
- Architecture of WATM

**22. Known gaps, if any:**

1. Method for locating coverage gaps in wireless communication services
2. PROCESSING MEASUREMENT GAPS IN A WIRELESS COMMUNICATION SYSTEM
3. Sandy exposes gaps in wireless system during emergency

**23. Discussion topics, if any:**

1. Different generations of cellular networks
2. WAN and PAN
3. Bluetooth
4. Frequency reuse, cell splitting, hand off strategies
5. Different types of multiple access techniques
6. Difference between wireless and fixed telephone networks
7. CDMA and GPRS mobile application protocol
8. OFDM block diagram

**1. Different generations of cellular networks:**

# Evolution of Cellular Systems

1st. Generation  
(1980s)

Analog

NMT CT0  
TACS CT1  
AMPS

2nd.  
Generation  
(1990s)  
Digital

GSM DECT  
DCS1800 CT2  
PDC PHS  
IS-54  
IS-95  
IS-136  
UP-PCS

3rd.  
Generation  
(2000s)

IMT-2000  
CDMA2000  
W-CDMA

GS

# ❖ Generations of Cellular Systems

- Generations of cellular systems include:
  - AMPS → 1<sup>st</sup> generation
  - GSM → 2<sup>nd</sup> generation
  - W-CDMA → 3<sup>rd</sup> generation
- Cellular systems operate based on various protocols, and use RF (radio frequency) waves that propagate through the air for transmission of information. These systems typically use the 800-900 MHz or 1800-1900 MHz frequency band of the radio spectrum.
- *But what is the radio spectrum?*

## 2&3 WAN,PAN AND BLUETOOTH:

• . Personal Area Networks (PAN)• A personal area network (PAN) is a computer network used for communication among computer devices, including telephones and personal digital assistants, in proximity to an individuals body. • The devices may or may not belong to the person in question. The reach of a PAN is typically a few meters. • PANs can be used for communication among the personal devices themselves (intrapersonal communication), or for connecting to a higher level network and the Internet (an uplink). • Personal area networks may be wired with computer buses such as USB and FireWire. • A wireless personal area network (WPAN) can also be made possible with wireless network technologies such as IrDA, Bluetooth, Wireless USB, Z-Wave and ZigBee.

□ 2. • Bluetooth uses frequency-hopping spread spectrum, which chops up the data being sent and transmits chunks of it on up to 79 bands (1 MHz each; centered from 2402 to 2480 MHz) in the range 2,400-2,483.5 MHz (allowing for guard bands). • This range is in the globally unlicensed Industrial, Scientific and Medical (ISM) 2.4 GHz short- range radio frequency band. • Bluetooth is a packet-based protocol with a master- slave structure.



- 3. • One master may communicate with up to 7 slaves in a piconet; all devices share the masters clock. • The devices can switch roles, by agreement, and the slave can become the master at any time. • Baseband Error Correction – Three types of error correction are implemented in Bluetooth systems, • 1/3 rate forward error correction (FEC) • 2/3 rate FEC • Automatic repeat-request (ARQ)•
- 4. ZigBee• ZigBee is a specification for a suite of high level communication protocols using small, low-power digital radios based on the IEEE 802.15.4-2003 standard for Low-Rate Wireless Personal Area Networks (LR-WPANs)• Applications: – Wireless light switches with lamps – Electrical meters with in-home-displays – Consumer electronics equipment via short-range radio needing low rates of data transfer. – Home Entertainment and Control — Smart lighting, advanced temperature control, safety and security, movies and music – Wireless Sensor Networks — Starting with individual sensors like Telosb/Tmote and Iris from Memsic. • The technology defined by the ZigBee specification is intended to be simpler and less expensive than other WPANs, such as Bluetooth.
- 5. ZigBee• ZigBee is targeted at radio-frequency (RF) applications that require a low data rate, long battery life, and secure networking. • ZigBee is a low-cost, low-power, wireless mesh networking standard.



Management Information Systems  
Mobile Commerce

## Wide-Area Wireless Networks

Graduate School of Management & Economics

- Cellular Radio
  - 1st Generation
  - 2nd Generation
  - 2.5 Generation
  - 3rd Generation

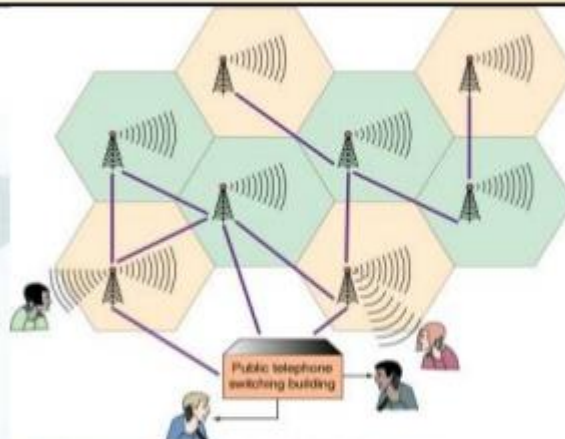

- Wireless Broadband or WiMax

## ⇒ CELLULAR CONCEPT

- The Cellular Concept was a solution of Spectral Congestion and user capacity problem.
- It offered very high Capacity in a limited Spectrum allocation without any major technological changes.
- The Cellular Concept is a System level idea which calls for replacement of single, high power transmitter (large cell) with many low power transmitters (small cells), each providing coverage to only a small portion of the service area.
- Every cell is then assigned a channel set, and these set can be reused at spatially separated locations.
- Neighboring base stations are assigned different sets (or group) of channels so that the interference between Base stations is minimized.
- As the demand of service increases, the number of base stations may be increased (along with a corresponding decrease in transmitter power to avoid added interferences), for providing additional radio capacity with no additional increase in radio spectrum.

## ⇒ FREQUENCY REUSE (Important)

- Cellular radio systems rely on intelligent allocation and reuse of channels throughout a coverage region.
- Each cellular base station is allocated a group of radio channels to be used within a small geographic area called a cell.

## Different types of multiple access techniques:

In case of mobile communication, which is a form of wireless communication, the only restraint on communication is the bandwidth restraint which means we have a limited frequency range that we can use for communication. Hence, we must somehow, allow multiple users communicate in the same frequency range.

Multiple Access Techniques are ways to access a single channel by multiple users. They provide multiple access to the channel. A “channel” refers to a system resource allocated to a given mobile user enabling the user to establish communication with the network (other users). Based on the type of channel, we can use a particular multiple access technique for communication.

The types of channel and the corresponding multiple access techniques are listed below:

- **Frequency Channels [FDMA - Frequency Division Multiple Access]** - Frequency band divided into small frequency channels and different channels are allocated to different users – like in FM radio. Multiple users can transmit at the same time but on different frequency channels.
- **Time-slot Within Frequency Bands [TDMA - Time Division Multiple Access]** – Each user is allowed to transmit only in specified time-slots with a common frequency band. Multiple users can transmit at the same frequency band at different times.
- **Distinct Codes [CDMA - Code Division Multiple Access]** – Users may transmit at the same time using the same frequency band but using different codes so that we can decode to identify a particular user.

We often use a combination of TDMA+FDMA to achieve a greater number of multiple access channels as explained below:

Transmission using different frequency bands at the same time = 2 channels.

Similarly, Transmission using different time slots but same frequency band = 2 channels.

But transmission using two frequency bands and two time-slots = 4 channels.

The above as well as the major three multiple access schemes are explained in the figure below:

## 24. References, Journals, websites and E-links:

### 1. Text books

1. Wireless Communications, Principles, Practice – Theodore, S. Rappaport, PHI, 2nd Edn., 2002.
2. Wireless Communication and Networking – William Stallings, PHI, 2003. .

### 2. Reference Books

1. Wireless Digital Communications – Kamilo Feher, PHI, 1999.
2. Principles of Wireless Networks – Kaveh Pah Laven and P. Krishna Murthy, Pearson Education, 2002.
3. Wireless Communications – Andrews F. Molisch, Wiley India, 2006.
4. Introduction to Wireless and Mobile Systems – Dharma Prakash Agarwal, Qing- An Zeng, Thomson 2<sup>nd</sup> Edition, 2006.
  1. [www.ieee.org](http://www.ieee.org)
  2. [www.williamstallings.com/Wireless1e.html](http://www.williamstallings.com/Wireless1e.html)
  3. <http://en.wikipedia.org/wiki/Wireless>
  4. <http://www.wirelesscommunication.nl/reference/about.html>

### Journals

1. Electronics for you
2. WCNC. 1999 IEEE Wireless Communications and Networking Conference (Cat. No.99TH8466)

3. Wireless Communications and Networking Conference, 1999. WCNC. 1999 IEEE  
Digital Object Identifier: 10.1109/WCNC.1999.797772 Publication Year: 1999

#### IEEE CONFERENCES

3. Virtual prototyping for mobile distributed wireless terrestrial communications systems and networks Christensen, E.R.; Ennis, M.; Todd, C.; MILCOM 97 Proceedings Volume: 1 Digital Object

Identifier: 10.1109/MILCOM.1997.648727 Publication Year: 1997 , Page(s): 329 - 333 vol.1

## IEEE CONFERENCES

4. ONU Placement in Fiber-Wireless (FiWi) Networks Considering Peer-to-Peer Communications Zeyu Zheng; Jianping Wang; Xiumin Wang; Global Telecommunications Conference, 2009.

GLOBECOM 2009. IEEE Digital Object Identifier: 10.1109/GLOCOM.2009.5425913  
Publication Year: 2009 , Page(s): 1 - 7

## 25. Quality Control Sheets

- a. Course end survey
- b. Teaching Evaluation

### Student List:

No.Admin/B.Tech/SR/22

Academic Year: 2014-15

Class / Section: ECE 41A

Rev. No. 00

Date: 29.11.2015

S.No	Roll No	Student Name	S.No	Roll No	StudentName
1			33		
2			34		
3			35		
4			36		
5			37		
6			38		
7			39		
8			40		
9			41		
10			42		
11			43		
12			44		

13			45		
14			46		
15			47		
16			48		
17			49		
18			50		
19			51		
20			52		
21			53		
22			54		
23			55		
24			56		
25			57		
26			58		
27			59		
28			60		
29			61		
30			62		
31			63		
32					
Total:					
<b>DEAN-ADMIN</b>					

**26. Group-Wise students list for discussion topics**

**GROUP-I:**

**GROUP-II:**

**GROUP-III:**

**GROUP-IV:**

**GROUP-V:**

**GROUP-VI:**



**GROUP-VII:**

**GROUP-VIII:**

**GROUP IX:**

**GROUP X:**

**GROUP XI:**
